

# Technical Service Manual

## USA Series

- ▲ USA 400
- ▲ USA 900
- ▲ USA 1310



REV. B

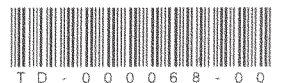

◆ USA 400

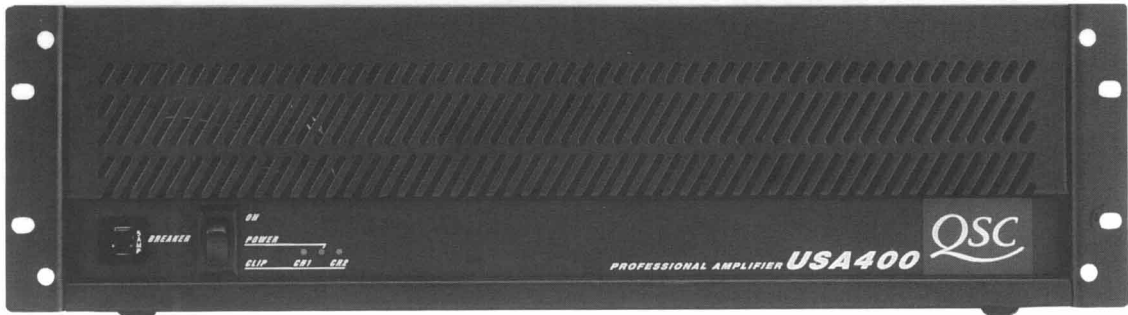

◆ USA 900

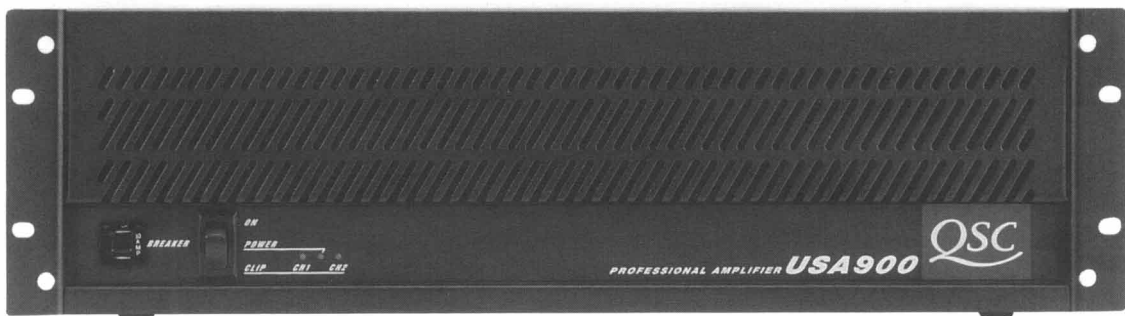

◆ USA 1310

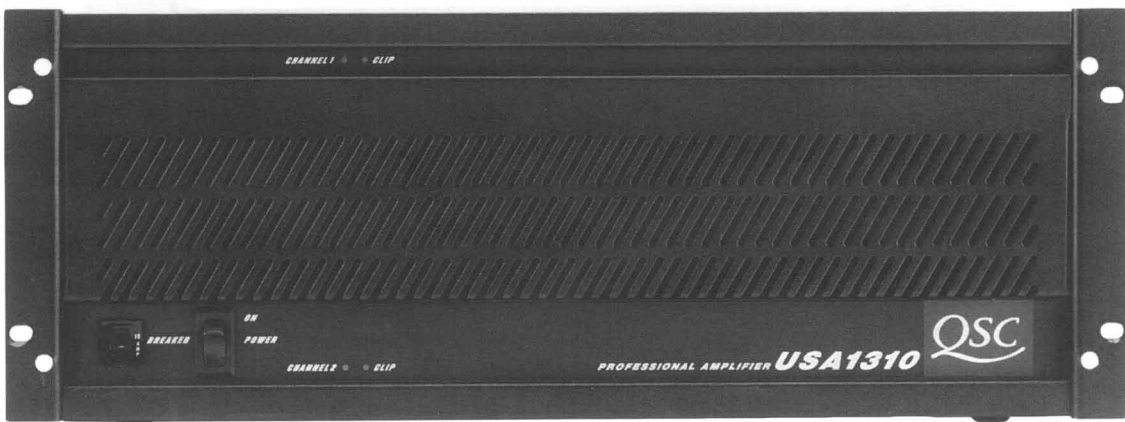

# USA SERIES SERVICE MANUAL

**USA400**  
**USA900**  
**USA1310**

QSC Technical Services

Wats: 1-800-772-2834

Local: 1-714-957-7150

Fax: 1-714-754-6173

QSC Online!

Online Computer Information System

1-714-668-7567

QSC Audio Products, Inc.

1675 MacArthur Blvd.

Costa Mesa, CA 92626

<http://www.qscaudio.com>

# Table of Contents

Product Specifications .....	1
Introduction & General Information .....	2
USA Series Test and Calibration .....	4
USA Series Troubleshooting .....	9
USA Series Parts List	
<i>USA Input Jack Plane Assembly</i> .....	17
<i>USA400 Main Board Assembly</i> .....	18
<i>USA400 Chassis Assembly</i> .....	19
<i>USA900 Main Board Assembly</i> .....	19
<i>USA900 Chassis Assembly</i> .....	20
<i>USA1310 Ch.1 Main Board Assembly</i> .....	20
<i>USA1310 Ch.2 Main Board Assembly</i> .....	21
<i>USA1310 Chassis Assembly</i> .....	22
Semiconductors .....	23
Chassis Drawings	
<i>USA400 Chassis Assembly</i> .....	24
<i>USA900 Chassis Assembly</i> .....	26
<i>USA1310 Chassis Assembly</i> .....	28
Wiring Diagrams	
<i>USA400 Wiring Diagram</i> .....	30
<i>USA900 Wiring Diagram</i> .....	32
<i>USA1310 Wiring Diagram</i> .....	34
Schematics	
<i>USA Series Input Jack Plane</i> .....	36
<i>USA400 Schematic</i> .....	37
<i>USA900 Schematic</i> .....	38
<i>USA1310 Schematic</i> .....	39
Printed Circuit Board Diagrams	
<i>USA400 / USA900 Main PCB</i> .....	40
<i>USA1310 Ch.1 Main PCB</i> .....	41
<i>USA1310 Ch.2 Main PCB</i> .....	42
<i>USA Series Jack Panel</i> .....	43

# USA Series Product Specifications

USA400

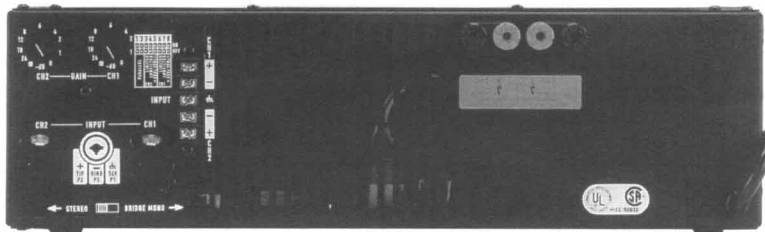

USA900

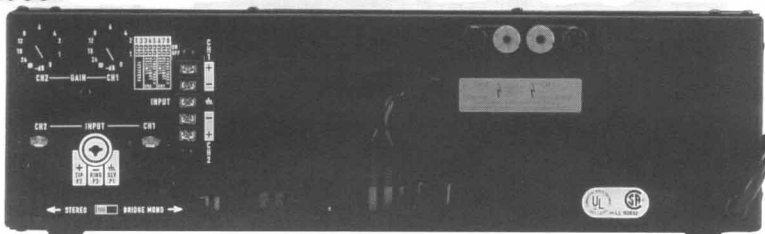

USA1310

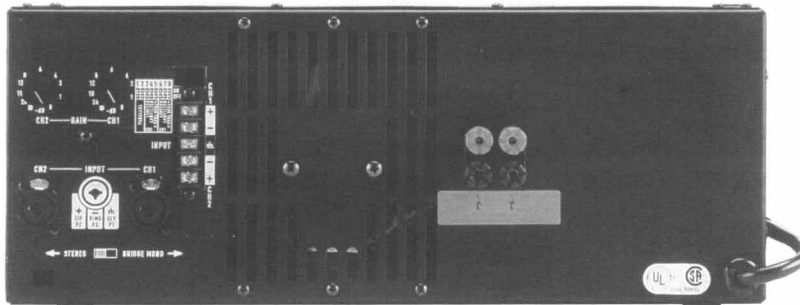

## USA400 USA900 USA1310

**Output Power (per channel, typical):**

Continuous Average Output Power both channels driven:

8 ohms, 20Hz - 20kHz, 0.1% THD                      110 watts      240 watts      375 watts  
 4 ohms, 1kHz, 1% THD                                      200 watts      450 watts      655 watts

Continuous Average Output Power bridged mono operation:

8 ohms, 1kHz, 1% THD                                      400 watts      900 watts      1310 watts

**Dynamic Headroom (dB):**

8 ohms    2.0                      2.0                      2.0

**Voltage Gain (dB):**    29                      32                      34

**Distortion:**

SMPTE-IM at rated power                                      Less than 0.025%

**Frequency Response:**    20Hz to 20kHz, +0, -1.0 dB, at 1 watt

**Damping Factor**    Greater than 200

**Noise (A weighted) Below Rated Power:**                      105dB                      104dB                      106dB

**Sensitivity (8 ohms) for Rated Power:**                      1.12 V RMS      1.16 V RMS      1.12 V RMS

**Input Impedance**    10k ohms unbalanced, 20k ohms balanced

**Dimensions**

Faceplate Width    Standard 19" Rack Mounting

Faceplate Height    5.25"                      5.25"                      7.0"

Chassis Depth    9.5"                      9.5"                      10.8."

**Weight**

Shipping, Lbs/kg    28/12.7                      37/16.8                      57/25.9

Net, Lbs/kg    24/10.9                      34/15.4                      54/24.5

# I n t r o d u c t i o n

This manual is prepared to assist service personnel with the repair and calibration of USA Series power amplifiers . The procedures described in this manual require advanced technical experience and sophisticated audio test equipment.



**CAUTION:** To reduce the risk of electric shock, do not remove the cover. No user-serviceable parts inside. Refer servicing to qualified service personnel.

**WARNING:** To prevent fire or electric shock, do not expose this equipment to rain or moisture.

## Documentation

This manual contains schematics, printed circuit board (PCB) drawings, parts lists, and mechanical assembly drawings. This information should be used in conjunction with the test and troubleshooting guide.

The electrical and electronic components are identified by circuit identification numbers on the schematics and the parts list. The test & troubleshooting sections refer to designations shown in the schematics.

## Equivalent Parts

Although many of the electronic components used in this product may be available from electronic suppliers, some components are specially tested and approved by QSC. A product repaired with non-QSC supplied components may not meet factory specifications. Repairs performed using non-QSC parts may void the product warranty. When in doubt, you may contact QSC Technical Services for assistance.

Parts orders to QSC should include the product model number, the part description, and the QSC part number (from the parts list in this manual). Parts will be shipped via UPS, F.O.B. Costa Mesa, California. Shipping, handling and COD charges may be added to the cost of the parts.

## Factory Repair

It may become necessary to return a product to the factory for repair. Call QSC Technical Services for return instructions. QSC Technical Services may be reached at (800) 772-2834.

## Test Equipment

For testing, as outlined in this manual, the following equipment will be needed.

### REQUIRED TEST EQUIPMENT

- Distortion Analyzer capable of 0.05% THD+N
- High Power Load Bank (8, 4, & 2 ohms)
- Function Generator
- 20MHz Oscilloscope
- Digital Multimeter
- Variac (0-140 VAC, 30-40A)

### SUGGESTED TEST EQUIPMENT

- Audio Precision - System One
- Thermocouple probe

Audio Precision test and procedures files are made available, free of charge, from QSC Technical Services by either sending a self addressed stamped envelope and a 3 1/2" disk to QSC, or by logging on to QSC Online and downloading the appropriate files.

# T e s t & C a l i b r a t i o n

**NOTE:** This test procedure will refer to the amplifier's channels as Ch1 (Channel 1) & Ch2 (Channel 2). Component designation will have the prefix "5" for Ch1 and "6" for Ch2.

## USA400 & USA900 Test Procedure

---

- SET-UP

1. Connect a test load to the output terminals of the amplifier.
2. Set the Stereo / Bridge switch to Stereo.
3. Connect a distortion analyzer with a resolution of 0.05%, 20-20kHz (or better) to the output terminals of the amplifier.
4. Connect a dual-channel oscilloscope to the following test points:
  - Ch1 - a 10X (vertical sensitivity - 2V/cm) scope probe to the channel speaker output.
  - Ch2 - a 1X scope probe (vertical sensitivity - 0.1V/cm) to the distortion analyzer output.
5. Connect scope Ch. 2 (0.1V/cm) to distortion output.
6. Set amp gain pots fully clockwise.
7. Connect the output of the signal generator to the input terminals of the amplifier and select an output of 1.00 VRMS, 1KHz sine wave.
8. Lift the ground on the scope and the distortion analyzer.
9. Verify that the programming switches on the input board are in the off position.

- POWER UP & MUTE DELAY TEST

1. Slowly raise the variac voltage and watch for excessive current draw (Line current greater than 1A a.c. at 120 Volts.) *This is slightly less for 240V.* Pause at 95VAC (200VAC European) for three seconds until the mute / protect circuit disengages. Raise to 120VAC (240V European).
2. Turn the power switch off and on a few times to verify the 2 - 3 second power-up muting delay.

- CHANNEL OUTPUT

1. Look for normal signal on the scope of channel 1. Switch the input signal and scope to channel 2 and repeat output test. Check for noisy / contaminated gain pots by observing general instability on your distortion waveform while adjusting the gain control levels.
2. Select an 8 ohm load and confirm that this product is passing 125 watts for USA400 and 270 watts for USA900 at 1KHz 1% distortion.

- BRIDGE MODE (1Vrms, sinewave, 1kHz)

Move the Bridge switch on the amp from the Stereo to Bridge position. Turn gain on CH2 fully counter clockwise (off). Remove the input plug from CH2. Check CH2 for full output with input applied to CH1. The output signal on CH2 should be 180 degrees out of phase with CH1 output signal. Turn power off and place the amplifier under test back into the Stereo mode.



- BIAS & RIPPLE (HUM) NULL ADJUSTMENT

HUM NULL:

1. Use 0.1% scale on distortion analyzer. Adjust TR2 hum-null trimpot for minimum signal distortion. Make this adjustment with your input signal at 20kHz below full output. Let the amplifier cool down.

CROSSOVER AND BIAS SETTING:

2. While still at 20kHz, reduce input signal 20dB (80%) from full output and adjust crossover trimpot (TR3a & b) for a less than 400mVpk-pk cross-over spike protruding from the noise trace on the scope.

If a distortion analyzer is not available, a less accurate crossover distortion and bias adjustment can be made by monitoring the driver transistor (Q1 & Q2) bias current. With the amp at room temperature, and no input signal plugged into the amplifier, measure the DC voltage across the emitter resistors of Q1 and Q2. Adjust TR3a,b to obtain about 100mV d.c.

- SHORT CIRCUIT CURRENT (*1Vrms, sinewave, 1kHz*)

1. Select a 2-ohm load and verify even clipping on both channels by adjusting a 1kHz input signal to just beyond 1VRMS (sine wave). Apply a short to the output binding posts of each channel one channel at a time and adjust the short circuit current limits. TR4a & b is for positive clip adjust and current limiting while TR5a&b is for negative clip adjust and current limiting. AC current draw from the wall of 2.0A on the USA400 and 4.5A on the USA900 (*1A, 240V and 2.25A, 240V respectively*) should be evident. If adjustment is necessary, a symmetrical adjustment of the wipers on TR4 and TR5 will be necessary to maintain even clipping. This balanced adjustment should achieve two things. The setting of a 2.0 A (USA400), or 4.5A (USA900) a.c. current draw from the line voltage while at the same time maintaining even clipping on the negative and positive portions of your output sinewave.
2. While the amplifier is driving a short between the black and red binding posts of the channel under test, observe the main supply rail voltages, ideally they will be no more than 3 volts from each other.
3. Next, an important thing to look for is that the channel will recover from a short into a 2 ohm load.
4. Perform the same procedure for the next channel to be calibrated.

- 2 OHM POWER

Verify correct loading down to 2 ohms. 2 ohms is allowed to clip somewhat unevenly, but must pass 250W on the USA400 and 550W on the USA900 (one channel driven, 1kHz, 1% THD). At this point, verify CLIP and PILOT LED's by adjusting your generator control until the channel is just above clipping.

- FREQUENCY RESPONSE

Set load to 8 ohms and scale your input to achieve 1 watt of power from the amplifier on each channel. Gain controls on the amplifier should be fully open. Check frequency response from 20Hz. (+0, -1dB at 1 watt) to 20KHz. (+0, -1dB at 1 watt) by sweeping random frequencies between these points. Check both channels.

- **POWER VS. DISTORTION TEST**

Check to ensure that both channels will produce rated power at 20Hz, 2KHz, and 20kHz. While verifying rated power check that at all frequencies the distortion measurement is less than 0.1% (just below the onset of clipping.)

- **THERMAL TEST**

Set input frequency to 2KHz and short both channels while they are producing power into a load. AC current of about 2.0-3.0 (4.0 - 5.0 for USA900) amps PER CHANNEL should be read from the 120v (240v) line voltage. Verify that the PTC circuit causes thermal shutdown after an extended period. When shutdown occurs, verify AC idle of .75 to 1.5 amps. While waiting for thermal shutdown, verify presence of IC (IC1a & b) voltage at pins 4 and 8 of 4 - 8 volts d.c..

- **CM TEST**

Check the Common Mode Rejection by inserting the 1/4" input jack halfway into each channel and observe a 50% signal reduction, and a 180 degrees phase inversion at the output of the amplifier under test.

- **OUTPUT NOISE**

Set the amplifier **GAIN** to 0dB, with a 2kHz 1.00Vrms input signal. Note the output level. Remove the signal input connector and measure the residual noise level produced into the load. The noise signal should be 100 dB down from the full output power point measured. A signal to noise ratio should be better than 100dB (A weighted). Check both channels.

- **FINAL CHECK**

This completes the electronic test procedure. Inspect the amplifier for mechanical defects. Inspect the solder connections. Reassemble the amplifier and verify the amplifier's operation before returning the product to service.

## USA1310 Test Procedure

---

- **SET-UP**

1. Connect a test load to the output terminals of the amplifier.
2. Set the Stereo / Bridge switch to Stereo.
3. Connect a distortion analyzer with a resolution of 0.05%, 20-20kHz (or better) to the output terminals of the amplifier.
4. Connect a dual-channel oscilloscope to the following test points:
  - Ch1 - a 10X (vertical sensitivity - 2V/cm) scope probe to the channel speaker output.
  - Ch2 - a 1X scope probe (vertical sensitivity - 0.1V/cm) to the distortion analyzer output.
5. Connect scope Ch. 2 (0.1V/cm) to distortion output.
6. Set amp gain pots fully clockwise.
7. Connect the output of the signal generator to the input terminals of the amplifier and select an output of 1.00 VRMS, 2KHz sine wave.
8. Lift the ground on the scope and the distortion analyzer.
9. Verify that the programming switches on the input board are in the off position.

- **POWER UP & MUTE DELAY TEST**

1. Slowly raise the variac voltage and watch for excessive current draw (Line current greater than 1A a.c. at 120 Volts.) *This is slightly less for 240V.* Pause at 95VAC (200VAC European) for three seconds until the mute / protect circuit disengages. Raise to 120VAC (240V European).

2. Turn the power switch off and on a few times to verify the 2 - 3 second power-up muting delay.

- CHANNEL OUTPUT

1. Look for normal signal on the scope of channel 1. Switch the input signal and scope to channel 2 and repeat output test. Check for noisy / contaminated gain pots by observing general instability on your distortion waveform while adjusting the gain control levels.
2. Select an 8 ohm load and confirm that this product is passing 400 watts at 1KHz 1% distortion.

- BRIDGE MODE

Move the Bridge switch on the amp from the Stereo to Bridge position. Turn gain on CH2 fully counter clockwise (off). Remove the input plug from CH2. Check CH2 for full output with input applied to CH1. The output signal on CH2 should be 180 degrees out of phase with CH1 output signal. Turn power off and place the amplifier under test back into the Stereo mode.

- BIAS ADJUSTMENT

While still at 20kHz, reduce input signal 20dB (80%) from full output and adjust cross-over trimpot (TR1a & b) for a less than 400mVpk-pk cross-over spike protruding from the noise trace on the scope. An idle current (no signal applied with an 8 ohm load) should be less than or equal to 1.2A a.c.

If a distortion analyzer is not available, a less accurate crossover distortion and bias adjustment can be made by monitoring the driver transistor (Q1 & Q2) bias current. With the amp at room temperature, and no input signal plugged into the amplifier, measure the DC voltage across the emitter resistors of Q1 and Q2. Adjust TR1a,b to obtain about 80mV d.c.

- SHORT CIRCUIT CURRENT

1. Select a 4-ohm load and verify even clipping on both channels by adjusting a 1kHz input signal to just beyond 1.13VRMS (sine wave) with gain control fully up on the channel under test. Apply a short to the output binding posts of each channel one channel at a time and adjust the short circuit current limits. TR2a & b is for current limit adjustments. Upon shorting the channel, AC current draw from the wall of 5.5A (2.5A, 240V) should be evident.
2. While the amplifier is driving a short between the black and red binding posts of the channel under test, observe the main supply rail voltages, ideally they will be no more than 3 volts from each other.
3. Next, an important thing to look for is that the channel will recover from a short into a 2 ohm load and clip evenly. In order to set even clipping, adjust TR3a&b. If an adjustment with TR3 is necessary it is very important to re-measure the d.c. voltage rails and ensure that they do not deviate more than 3 volts from each other (ignoring the polarity difference).
4. Perform the same procedure for the next channel to be calibrated.

- 2 OHM POWER

Verify correct loading down to 2 ohms. 2 ohms is allowed to clip somewhat unevenly, but must pass 1000W (one channel driven, 1kHz, 1% THD). At this point, verify CLIP and PILOT LED's by adjusting your generator control until the channel is just above clipping.

- FREQUENCY RESPONSE

Set load to 8 ohms and scale your input to achieve 1 watt of power from the amplifier on each channel. Gain controls on the amplifier should be fully open. Check frequency

response from 20Hz. (+0, -1dB at 1 watt) to 20KHz. (+0, -1dB at 1 watt) by sweeping random frequencies between these points. Check both channels.

- **POWER VS. DISTORTION TEST**

Check to ensure that both channels will produce rated power at 20Hz, 2KHz, and 20kHz. While verifying rated power check that at all frequencies the distortion measurement is less than 0.1% (just below the onset of clipping.)

- **THERMAL TEST**

Set input frequency to 2KHz and short both channels while they are producing power into a load. AC current of about 4.0-5.0 amps PER CHANNEL should be read from the 120v (240v) line voltage. Verify that the PTC circuit causes thermal shutdown after an extended period. When shutdown occurs, verify AC idle of .75 to 1.5 amps. While waiting for thermal shutdown, verify presence of IC (IC1a & b) voltage at pins 4 and 8 of 4 - 8 volts d.c..

- **CM TEST**

Check the Common Mode Rejection by inserting the 1/4" input jack halfway into each channel and observe a 50% signal reduction, and a 180 degrees phase inversion at the output of the amplifier under test.

- **OUTPUT NOISE**

Set the amplifier **GAIN** to 0dB, with a 2kHz 1.00Vrms input signal. Note the output level. Remove the signal input connector and measure the residual noise level produced into the load. The noise signal should be 100 dB down from the full output power point measured. A signal to noise ratio should be better than 100dB (A weighted). Check both channels.

- **FINAL CHECK**

This completes the electronic test procedure. Inspect the amplifier for mechanical defects. Inspect the solder connections. Reassemble the amplifier and verify the amplifier's operation before returning the product to service.

# T r o u b l e s h o o t i n g

## Current Draw

*(Circuit breakers and fuses blow. Burning smell or smoke)*

---

### *Symptoms: All Models*

- Fuses immediately blow
- Amplifier quickly gets very hot
- Line circuit breakers tripping upon turn on
- Amplifier exhibits very loud hum with chassis vibration
- Amplifier emits smoke
- A burning smell is emanating from the amplifier

### *Possible Causes:*

- **EXCESSIVE CURRENT WITHOUT SIGNAL PRESENT**  
The amplifier draws high current when the AC supply voltage is first applied. This symptom may mean that there is a short in the power stages of the circuit.  
This could also be a misadjusted bias setting. See calibration procedures in this manual for setting bias.
- **FAST CURRENT DRAW** (increases rapidly at only a few volts AC):
  1. Reversed or shorted main bridge rectifier B1 (B3, USA1310).
  2. Both supply clamping diodes D6, D7 reversed or shorted (D3, D4, USA1310).
  3. Output transistors or both drivers shorted.
- **MEDIUM CURRENT DRAW** (increases slowly, can go to 30 VAC before current becomes excessive.):
  1. Single polarity driver or output short.
  2. Single supply clamping diode D6 or D7 reversed or shorted (D3, D4, USA1310).
  3. Open or missing bias diodes D1, D2 or bias trim pot TR3 and R38 (D5, D6, TR1, R4, USA1310).
- **SLOW CURRENT DRAW** (above 60 volts AC before current begins to increase, amp may pass signal):
  1. Severely misadjusted bias circuit or defective bias diodes D1 & D2.
  2. Severe oscillation causing current drain.
- **RUNAWAY CURRENT DRAW** (30-40V AC before current begins to increase or runaway):
  1. A reversed filter capacitor: caution, may vent explosively.

## Protection, Muting Circuit, and Power On/Off Delay

*(The amplifier locks up or does not startup and shut off correctly)*

### **Symptoms: All Models**

#### **USA400, & USA900**

- Both channels do not come out of protect
- Amplifier will not thermally protect
- Pilot LED not working
- Too little or too much muting delay

#### **USA1310**

- Relay won't turn on
- Poor mute circuit timing
- No D.C. protect
- Shuts off under signal
- No Red protect LED
- No thermal shutdown

#### **Possible Causes: USA400, & USA900**

- BOTH CHANNELS DO NOT COME OUT OF PROTECT
  1. Q11 or Q12 shorted base emitter
  2. Voltage on Z5 should be 14v - 15v. If this voltage is low, check for leaky E8, E9, defective Z5, or open R33.
  3. Check for open LD3 and open PTC.
- AMPLIFIER WILL NOT THERMALLY PROTECT
  1. Check for shorted LD3 and PTC, incorrect R35, R34, open pilot LD2, or open R39.
- MUTING DELAY

Too Much: Check for open LD2 or R39, incorrect R33, R34, R35 or shorted LD3.  
Too Little: Check for incorrect E8, E9, or R33.
- PILOT LED NOT WORKING
  1. Check for shorted or open pilot LD2. Check R39.

#### **Possible Causes: USA1310**

- RELAY WON'T TURN ON
  1. Check speaker bus for DC; if over 10V DC is present, the protect circuit is operating normally to prevent operation. If DC is present, (presumably without current draw), continue below; if no DC is present on the output, skip to the section below other protection related faults.
  2. Check relay power voltage. With relay off, voltage at E5 should measure 36V (set by Zener Z6). If not check R31, D9, or shorted Z6.
  3. If power voltage is OK, check voltage on timing capacitor E4. Should rise to 12-15V, in three seconds, which triggers Q19. If not, check R19, R20, E4's polarity, or for a shorted Q20. If timing voltage is OK, check relay transistor Q21. If good, a 47K resistor from base to speaker bus should activate relay.
  4. If relay driver Q21 is OK, check driver Q19 and LED LD3.
- POOR MUTE CIRCUIT TIMING

NO MUTING DELAY (*relay or circuit is "stuck on"*)

1. Relay driver Q21 shorted or wrongly mounted. Check by jumping base to emitter, should turn it off if OK.
2. Driver Q19 shorted or wrongly stuffed (check by jumping base to emitter as above).
3. D7 reversed (charges timing capacitor E7 immediately)
4. R20 low (fast E4 charge)
5. R19 low (low voltage on E4 turns Q19 on too soon)
6. Missing or high R23 (no off current)

#### EXCESSIVE MUTING DELAY

1. Check timing capacitor E4 voltage. If it rises normally but circuit is slow to turn on, check Z7 (lift temporarily while checking circuit), LD3 bad or intermittent, R23 too low.
2. Timing capacitor voltage wrong; check for R19, R20, reversed E4, missing R22.
3. Reversed or wrong Q20 type.

#### • NO D.C. PROTECT

DC FAULT WITHOUT CURRENT DRAW. In most cases, shorts in the output circuit will cause current draw, but certain shorts will only cause DC offset in the output. In both cases, measure the various circuit voltages, and look for abnormal values to help trace the fault, which can be a solder or component short (zero volts), reversed zener or diode (.6V) reversed electrolytic (several volts), or wrong value parts (abnormal voltage). Look at the following points in the circuit.

1. Shorted IC rail, sometimes both shorted together; including input cable connectors and jacks
2. Defective Z2-3 gives zero volts on IC rail.
3. Collector-base short on driver (rare without further damage)
4. Sometimes IC forces the rest of the circuit into DC due to shorts in the feedback network, etc.
5. To check this, remove IC, check for +15V, -15V on IC rails, and balanced voltages in the drivers and outputs. If so, output stage is probably OK, look for problems in IC, or its associated parts.
6. Defective or reversed IC (pull and check voltages).
7. R30 missing or very high.
8. B2 defective or wrongly mounted on PCB.
9. Q20 defective or wrong type.
10. D7 reversed (also no muting delay).
11. Replace LD-3 if voltage drop across it is less than 1.5V.

#### • SHUTS OFF UNDER SIGNAL

1. E6 missing, defective, or much too small.

#### • NO RED PROTECT LED

Check LED voltage. If over +2V, LED is defective. If 0V with relay off (meaning no positive voltage to LED), check for solder short, or there is no "protect" power, (missing R29), which defeats shut-down circuits. Be sure to correct before proceeding.

#### • NO THERMAL SHUTDOWN

1. Short amplifier load with full signal to raise heat sink temperature and put voltmeter across PTC, (yellow sensor on heat sink), looking for voltage across PTC to rise from .7V cold to about 5.5V at shutdown.
2. No Red "Protect", may have no R29, which defeats whole thermal circuit (no voltage across PTC).
3. If the PTC reaches 6V but won't shut down, check Z7, or relay drive circuit stuck on (see above).

4. If red "protect" /R12 is OK, but no voltage across PTC, then the PTC is defective or shorted (lift temporarily or replace with 10K pot, confirm shutdown).

## Faults with Signal Present

*(The amplifier passes a signal but is not running correctly)*

---

### **Symptoms: All Models**

- Output power "breaking up"
- 'Ringing' sound with no input to amplifier
- Output collapses into a 8, 4 or 2 ohm load
- Voltage rails ok without signal.
- Amplifier gets too hot
- One channel clips prematurely
- Excessive hum with no input to amplifier

### **Possible Causes:**

- OUTPUT POWER "BREAKING UP" (*Output distorted*)
  1. Hum-null components may have burned open. Check R7, R8 and TR2.
  2. Ground traces may be bad. Check for continuity between speaker ground, input ground and ac ground.
- "RINGING" SOUND WITH NO INPUT TO AMPLIFIER
  1. C2 and/or C4 (C4, C7, USA1310) may be bad.
  2. Check op amp IC1.
- OUTPUT COLLAPSES INTO A LOAD
  1. No continuous ground between main pcb to heatsink through pem stud. The spring tooth lock washer may not be biting through anodized surface on main heatsink.
  2. Misadjusted TR4 or TR5.
  3. Check for R20 and R21.
- VOLTAGE RAILS OK WITHOUT SIGNAL *Collapses with a signal*
  1. E2 or E3 leaking.
  2. Check for capacitance value of C2 and C4 (C7, C13, E1, USA1310).
- AMPLIFIER GETS TOO HOT WITHOUT LOAD
  1. TR3 (TR1, USA1310), misadjusted, opened or burned.
  2. Incorrect bias diode (should be 1N4934) D1, D2 (D5, D6, USA1310).
  3. Missing C2 or C4 (C4, C7, USA1310). High frequency oscillations evident.
  4. Open R17, R18 (R16, R17, USA1310).
  5. Defective op amp IC1. Unstable and generating high frequencies).
- ONE CHANNEL CLIPS PREMATURELY
  1. R15 or R16 may be open.
  2. Misadjusted TR4 & TR5.
  3. Into a 4 ohm load, check for open R22, or open D4 & D5 (D1 & D2, USA1310).
  4. Check R7 & R8 for open or incorrect value.



5. Check for open R12, R13, R20, R21 (R14, R15, R52, R53, USA1310)
  6. 450 ohm chargeback resistor R22 may be open.
  7. Check for open on D4 and D5.
- EXCESSIVE HUM WITH NO INPUT TO AMPLIFIER
    1. TR2 (hum-null trim potentiometer) misadjusted, opened or burned.
    2. Check for mismatched capacitance value of output filter capacitors.

## ***Instability***

*(Gain problems, spurious noises, and oscillations)*

### **Symptoms: All Models**

- General Output Distortion
- "Ringing" sound with no input to amplifier
- Excessive or unbalanced crossover
- Output waveform appears "fuzzy"

### **Possible Causes:**

*First, distinguish between instability (fuzziness), "ringing" which is momentary instability after a transition, "step" distortion, crossover distortion (both often show ringing), or general distortion.*

- GENERAL OUTPUT DISTORTION
  - SEVERE:  
All loads, often with current draw: usually very low or missing slew rate capacitor C4, or feedback capacitor C2.
  - MEDIUM:  
Especially with a light load, often too high a value of a stability capacitor; check feedback capacitor C2, secondary stability capacitors C9, (C5,6 USA1310); and output filter R32/C5 (USA1310-R27,28/C10). Jump with comparable value, if better, replace with increased value, if worse, try replacing with 50% lower value).
  - LOW GAIN:  
Suspect open circuit in feedback shunt R5 (USA1310-R7/E1). Check for broken circuit trace. Substitute IC, and check IC socket for contamination.
- "RINGING" SOUND WITH NO INPUT TO AMPLIFIER
  - Usually indicates marginal instability, usually triggered after passing through the crossover. Can indicate problem in "minor" stability components. Also check output filter.
  - Possibly the crossover is larger than usual.
- EXCESSIVE OR UNBALANCED CROSSOVER (*Excess notch or ringing at zero crossing*)
  - Severe: shorted bias diode D1-2 (D5, D6, USA1310).
  - Moderate: Out-of-spec bias diodes.
  - Defective bias trimmer components TR3 (TR1, USA1310) and R38 (R54, USA1310).
  - Check for open base resistors R17,18 (R16, R17, USA1310) on output devices.

- OUTPUT WAVEFORM APPEARS "FUZZY"  
Instability on one side of the waveform:  
Add .015uF trimmer bypass capacitor around bias trimmer TR3 (TR1, USA1310).  
Check/adjust driver emitter capacitors C8 and C9 (C5,6 on USA1310).

## ***Power Supply and Voltage Rail Balancing***

*(Uneven rails and power supply problems)*

*Symptoms : All MODELS*

- Current limiting wrong
- Current limiting too high into short
- IC Rail too high into short
- Current limiting too low into short
- Uneven voltage rails

### ***Possible Causes:***

- CURRENT LIMITING WRONG  
Current limits should remain high down to 2 ohms, and collapse to a lower value for short circuits. This is caused by the IC rails going from normal 14 - 15 volts to about 5-6 volts. Current limit trimmers TR4 & TR5 (TR2 on USA1310) permits adjustment of each channel to specified range. See Test & Calibration Procedures for correct adjustment of the current limiting.
- CURRENT LIMITING TOO HIGH INTO SHORT (*IC RAILS CHECK NORMAL 5-6 volts*)
  1. Reversed or shorted 3.9 or 4.7V zeners Z15, Z16.
  2. Shorted bias diode D1,2 (also shows severe crossover), (D5, 6, USA1310).
- IC RAIL TOO HIGH INTO SHORT
  1. Check op amp (weak output current).
  2. Clip LED open.
  3. B2 defective, (B1, USA1310)
  4. Check for short circuit current balance on the USA400 and USA900 by measuring the main rail voltages during short circuit; they should be balanced within 3V. If severely offset, check Z3 (3.9V) and Z4 (4.7V) for correct voltage, and check values of R15 and R16.
- CURRENT LIMITING TOO LOW INTO SHORT AND 2 OHM LOAD  
IC RAILS OK
  1. Bias resistor R12, R13 high.
  2. Very low gain driver transistors (see below).
  3. Missing connection or emitter resistors in some of the paralleled output transistors.
- CURRENT LIMITING TOO LOW INTO SHORT ONLY (*OK into normal loads*)
  1. Check Clip LED shorted, 1.5A rectifier B1 shorted.
  2. 3.9 or 4.7V zeners high (7.5V or 15V).

- OK INTO SHORT BUT LOW INTO 2 OHMS: *(Usually on one side only)*  
 IC RAIL LOW (driving two ohms even before clipping): check for high or missing charge-back R22 (USA1310-R49), or missing/reversed charge-back diodes D4 or D5 (usually causes premature clipping at 4 ohms as well).  
 IC RAIL OK (until clipping starts) usually indicates low output section gain caused by weak driver, open output devices, or open emitter resistors. Also check value of driver emitter resistors R15, R16.
- UNBALANCED RAIL VOLTAGES: *(USA400 and USA900)*  
 Rail voltage is determined by R7 and R8 from the positive and negative rails.  
 If the amplifier is passing a signal but clipping unevenly due to uneven rail voltages, check and replace R7,8 (47K, 1watt, Metal Oxide).

NOTES \_\_\_\_\_

***USA1310 Power Supply***

The USA1310 power supply has a transformer center-tap return (DC-coupled), so the rails are forced to remain balanced. Check current balance by raising scope gain during short, and looking at the small voltage across the residual resistance of the short. The voltages (and thus currents) must be balanced within 33% (2:3 ratio maximum). They may be quite uneven. If so, check Z4 (3.9V) and Z1 (4.7V) for correct voltage, check values of R14 and R15, and if necessary adjust TR3 to balance the currents. Concentrate on the parts mentioned above, connected to the side with the high current (remember "reverse" polarity of QSC circuit –see below).

***Driver Transistor Gain***

To check driver gain, note the "REVERSED" polarity of QSC circuitry. The positive side of the circuit pulls the rails and output DOWN and thus is responsible for NEGATIVE output problems; the negative side of circuit is responsible for positive output. First, confirm their value, and then scope probe or measure the DC voltage on driver emitter resistors R12 or R13. If the driver's emitter resistor on the weak side has low voltage, its current is low, caused by poor drive or low gain. Inspect drive components shown above in Short Circuit Limit sections, or substitute drivers with an approved part. If a driver shows equal or greater current, it is OK and is trying to overcome weakness in outputs. Check that all devices and emitter resistors are good.

***How to determine which power transistors are shorted***

Determine which power supply rail (+ or -) is being clamped to ground. A positive side short (Q1, Q3 - Q10) will clamp the positive rail to ground, and a negative side short (Q2, Q11 - Q18) will clamp the negative rail to ground.

Raise the AC supply voltage current until the current draw is 2-5 amps. Measure the voltage on the supply rail and output transistors. A hard short to ground will read virtually zero volts. A shorted output device will read 0-5V depending on the short current.

Confirm that a voltage drop exists across that device's emitter resistor as well. A measurement of .6-1V above ground indicates clamping due to reversed or defective diode D6-7, or a shorted output. A measurement of 1-2 volts could mean a bad driver, but the outputs may be OK (especially if all emitter resistors have the same voltage drop).

Determine which individual devices in a parallel bank are shorted by measuring the voltage across the emitter resistors on the side with the low rail (the faulty side). The shorted devices will draw more current, causing higher voltages on their emitter resistors. The good devices on the opposite rail will all be conducting equal current.

If the base voltage to a group of outputs measures zero, there is a probable solder short to the heat sink or an output collector-to-base short (rare). If output collector to base junction is shorted, all outputs on the same bank must be removed from the circuit board and check the same collector to base junction carefully.

Check for a driver transistor short by measuring across the emitter resistors R12 and R13 (USA1310-R12/13). If the voltage drop is near zero, there is no driver transistor current draw and no driver transistor short. Don't forget to check for open emitter resistors (burned open by a shorted output device).

## USA Series Jack Plane Assembly

Part Number	Description	Reference
CA-110001-10	CAP SM 100PF, 5%, 500V	C307,407
CA-410004-10	CAP CER .1UF 20% 50V	C31
CA-415001-10	CAP MYLAR .15UF 5% 100V	C305,405
CA-422001-10	CAP MYLAR .22UF 5% 50V	C302,303, C402,403
CA-610002-10	10UF,35V,20%,RADIAL ELECT	C306,406
CA-647001-10	CAP LYTIC RL 47UF 10% 10V NP	C301,401
CA-710001-10	CAP LYTIC RL 100UF 20% 35V	C32,33
CO-000005-BS	5 POSITION BARRIER STRIP	J31
CO-000086-00	CONN VERT COMBO XLR/JACK	J301,401
CO-640385-AH	HEADER PCB.156 16-POS RT ANGLE	J32
HW-060040-PS	#6-32 X 4 PEM STUD	
HW-060120-SO	STANDOFF,1/4" HEX AL 6-32X3/4"	
HW-060150-SO	#6-32 X 29/32" STANDOFF	
IC-000032-00	IC LIN DUAL OP AMP MC33178P	U301,401
IC-000037-00	IC LIN DUAL OP AMP TRANSCOND	U31
NW-062010-FW	#6 FLT WSHR,SAE,ZINC,3/64 THK	
PC-001325-00	USA 2 JACKPLANE PCB	
PT-320300-CR	RES VAR IT 20K 20% 0.2W	R306,406
QD-000063-10	XISTOR PNP TO-92 40V 0.2A 1.5W	Q301,302, Q401,402
QD-004004-DX	DIODE RECT DO41 400V 1A	D31-34
RE-010005-BC	RES CF 100 5% 1/4W	R313,314, R413,414
RE-023701-BM	RES MF 237 1% 1/4W	R317,417
RE-041201-BM	RES MF 412 1% 1/4W	R316,416
RE-053601-BM	RES MF 536 1% 1/4W	R318,418
RE-110005-BC	RES CF 1K 5% 1/4W	C305,405
RE-147005-BC	RES CF 4.7K 5% 1/4W	R302,307, R402,407
RE-156201-BM	RES MF 5.62K 1% 1/4W	R308,310, R408,410
RE-175001-BM	RES MF 7.50K 1% 1/4W	R315,415
RE-210001-BM	RES MF 10.0K 1% 1/4W	R301,303, R312,401, R403,412
RE-220001-BM	RES MF 20.0K 1% 1/4W	R309,409, R311,411
RE-234801-BM	RES MF 34.8K 1% 1/4W	R304,404
RE-339005-BC	RES CF 390K 5% 1/4W	R319,419
SW-000008-DS	SWITCH, DIP, 8 POSITION	SW31

## USA 400 Main Board Assembly

Part Number	Description	Reference
CA-047001-10	CAP CER 47PF 10% 100V NPO	C1AB,2AB, C6AB
CA-222002-10	.0022UF,200V,10%,MYLAR	C12AB C4AB,11AB,
CA-233001-10	CAP MYLAR .0033UF 10% 100V	C8AB,9AB
CA-310001-10	CAP MYLAR .01UF 10% 100V	C7AB
CA-368001-10	CAP MYLAR .068UF 5% 100V	C3AB,5AB
CA-368250-AS	CAP SURGE .068UF 20% 250VAC	C10
CA-422002-10	CAP MPOLY 0.22UF 10% 250V	C22AB
CA-547002-10	4.7UF,16V,20% RADIAL NON-POLAR	E1AB
CA-547003-10	CAP LYTIC RL 4.7UF 10% 160V	E8
CA-647002-10	CAP LYTIC RL 47UF 20% 50V	E9
CA-722002-10	CAP LYTIC RL 220UF 20% 25V	E2AB,3AB
CA-833080-BE	CAP LYTIC RL 3300UF 20% 80V	E4AB-7AB
CH-140208-LX	1200/1400/1700 HEATSINK, FAB.	
CO-000008-IC	8 PIN IC SOCKET	IC1ab
CO-350432-AP	HEADER PCB 3 X 3 AMP TYPE	J101
HW-000001-FC	FUSE CLIPS	F1ab
HW-060100-PS	STUD PEM 6-32 X 0.625"	
HW-060405-SP	SPACER RND AL .25"OD X 5/32"L	
HW-060600-SO	STANDOFF 1/4" HEX AL 6-32 M/F	
IC-000021-00	IC LIN DUAL OP AMP 5532	IC1A,B
LB-120209-AX	LABEL, UL. FUSE CAUTION	
MS-000048-HS	HEAT SINK, ISOL TO-220	REF:Q1A,B, REF:Q2A,B
MS-070125-FU	7A, 125V, FUSE	F1ab
NW-060500-KP	#6-32 KEPS NUT	
PC-140044-LX	PCB FAB, MAIN PCB 1200/1400	
PL-000000-AF	ADHESIVE FEET	
PL-903125-SP	SPACER,ROUND,NYLON,0.125"L	D1A,B, D2A,B, L1A,B, R38A,B
PL-905156-SP	SPACER,ROUND,NYLON,#6,0.155"L	REF: LD3
PL-905325-SP	SPACER, ROUND,NYLON,#6,0.325"L	LD1ab,2
PL-909235-SP	HOLDER,LED,90 DEGREE,NYLON	LD1ab,2
PT-110000-AT	RES VAR IT 100 20% 0.15W CARB	TR3ab
PT-250000-AT	RES VAR IT 5K 20% 0.15W CARB	TR4ab,5ab
PT-422000-AT	RES VAR IT 220K 20% 0.5W CERM	TR2ab
QD-000004-TX	XISTOR NPN TO-92+60V 0.5A 1W	Q12
QD-000032-QD	XISTOR NPN TO-3 200V 16A	Q10B Q7A,8B,9A, Q3A,4B,5A, Q6B
QD-000033-QD	XISTOR PNP TO-3 200V 16A	
QD-000045-00	DIODE BRIDGE RECT DIP 200V 1A	B2AB
QD-000076-00	XISTOR NPN TO-220 250V	Q1A,B
QD-000077-00	XISTOR PNP TO-220 250V	Q2A,B
QD-000134-LG	LED GRN T-1 3/4	LD2
QD-000134-LR	LED RED T-1 3/4	LD1ab
QD-0003.9-ZT	DIODE ZNR 3.9V TESTED	Z3ab
QD-0004.7-ZT	DIODE ZNR 4.7V TESTED	Z4ab
QD-001340-LR	LED RED T-1 3/4 VOLTAGE REF	LD3
QD-004004-DX	DIODE RECT DO41 400V 1A	D10ab,11ab D4ab-7ab,8

## USA 400 Main Board Assembly (con't)

QD-004744-ZA	DIODE ZNR 15V 5% 1W 1N4744A	Z1ab,2ab,5
QD-004934-DX	DIODE RECT DO41 FAST 100V 1A	D1ab,2ab
QD-008599-TX	XISTOR PNP TO-92 60V 0.5A	Q11
QD-400400-BX	DIODE BRIDGE RECT 400V 40A	B1ab
RE-.02205-FW	RES WW 0.22 10% 3W	R23a,24b, R25a,26b, R27a,28b, R29a,30b
RE-.56005-EM	RES MOFP 5.6 5% 2W	R31ab
RE-.68005-DM	RES MOFP 6.8 5% 1W	R15ab,16ab
RE-000009-PT	RES PTC 90C 0.1K MAX COLD	PTC
RE-000050-NR	THERMISTOR NTC 50 OHM	R38ab
RE-001005-EM	RES MOFP 10 5% 2W	R32ab
RE-002205-DM	RES MOFP 22 5% 1W	R17ab,18ab
RE-015001-BM	RES MF 150 1% 1/4W	R14ab,36ab
RE-023701-BM	RES MF 237 1% 1/4W	R5ab
RE-030005-HW	RES WW 300 10% 5W	R22ab
RE-075001-BM	RES MF 750 1% 1/4W	R10ab
RE-110005-BC	RES CF 1K 5% 1/4W	R12ab,13ab
RE-120005-EM	RES MOFP 2K 5% 2W	R20ab,21ab
RE-147005-BC	RES CF 4.7K 5% 1/4W	R11ab
RE-162005-CC	RES CF 6.2K 5% 1/2W	R19
RE-168005-BC	RES CF 6.8K 5% 1/4W	R34,41
RE-210001-BM	RES MF 10.0K 1% 1/4W	R1ab,2ab, R3ab,4ab
RE-210002-CM	RES MF 10.0K 2% 1/2W	R6ab
RE-210005-EM	RES MOFP 10K 5% 2W	R39
RE-247005-CC	RES CF 47K 5% 1/2W	R9ab
RE-247005-DM	RES MOFP 47K 5% 1W	R35
RE-310005-BC	RES CF 100K 5% 1/4W	R7AB,8AB, R40
RE-315005-BC	RES CF 150K 5% 1/4W	R33
SC-061041-SP	#6 X 1/4" "A" P/P W/SCRAPING	PTC
SC-062050-PP	#6 X 5/16" "B" P/P ZINC	
SW-000151-SW	SWITCH, SLIDE, SPDT	SW1
WC-0.3022-JW	.3" JUMPER, WHITE, 22 GA SLD	R37,W3,8
WC-0.6022-JW	.6" JUMPER, WHITE, 22 GA, SLD	W2,9,19,28
WC-0.9022-JW	.9" JUMPER, WHITE, 22 GA, SLD	W1,4,15, W21,22,30, W31
WC-001102-SQ	INSUL. SLEEVE QSC 1102,.6",CLR	PTC
WC-1.2518-JW	1.25" JUMPER, WHITE 18 GA, SLD	W23
WC-1.5022-JW	1.5" JUMPER, WHITE, 22 GA, SLD	W11,12,16, W17,18,20 W5,6,7,10, W13,14,24, W25,26,27
WC-2.5018-JW	2.5" JUMPER, WHT, 18 GA, SLD	
XF-200016-CR	INDUCTOR 2UH 18AWG VERT MNT	L1ab

## USA 400 Chassis Assembly

Part Number	Description	Reference
CH-001850-00	USA400/900/SE185/425 FACEPLATE	
CH-140101-00	CHASSIS, SA/USA/SER.1 3 SPACE	
CH-140210-BX	1400 KNOB FABRICATION	
CO-000011-00	CONN DUAL 5-WAY BIND RD/BLK R	
CO-000012-00	CONN DUAL 5-WAY BIND RD/BLK L	
LB-000052-00	LABEL, cUL APPROVAL	
LB-000138-00	LABEL, INPUT, USA 2 SERIES	
LB-000143-00	LABEL, FACEPLATE USA 400 (DOM)	
LB-140102-00	LABEL OUTPUT SLC	
NW-040422-SW	TOSHIBA SHOULDER WASHER	
NW-060400-HN	#6-32 X 1/4" HEX NUT	
NW-100600-KP	#10-32 KEPS NUT	
PL-000001-SR	HEYCO 6W-1 STRAIN RELIEF 16/3	
PL-000003-CP	AC CORD PROTECTOR	
SC-030000-SC	3mm x 8mm,P/P,TYPE 1,BLK. OX.	
SC-060030-PU	#6-32 X 3/16 P/F UNDERCUT ZINC	
SC-060081-PP	#6-32 X 1/2" P/P BLACK	
SC-061081-PP	#6 X 3/8" "B" P/P ZINC	
SC-081101-SP	#8-18 X 5/8", TYPE 1 P/P BLACK	
SC-100121-PS	#10-32 X 3/4" P/P SEMS BLACK	
SW-000005-CB	5A. CIRCUIT BREAKER	
SW-000016-SW	SPST SNAP IN POWER SWITCH	
WC-000034-00	WIRE ASSY, 4.5", BLACK	
WC-001005-AX	QSC WIRE 1005, 2.5", BLACK	
WC-003050-AX	PWR CORD 100/120VAC	
WP-001325-00	PCB ASSY,JCKPLN,USA 2 SERIES	
WP-120044-TD	1200 MAIN DOM	
XF-001201-BX	XFMR P 1200 115/230V	

## USA 900 Main Board Assembly

Part Number	Description	Reference
CA-047001-10	CAP CER 47PF 10% 100V NPO	C1AB,6AB
CA-068001-10	CAP CER 68PF 10% 100V	C2A,B
CA-222002-10	.0022UF,200V,10%,MYLAR	C12AB
CA-233001-10	CAP MYLAR .0033UF 10% 100V	C4AB,11AB,
CA-310001-10	CAP MYLAR .01UF 10% 100V	C8AB,9AB
CA-368001-10	CAP MYLAR .068UF 5% 100V	C7AB
CA-368250-AS	CAP SURGE .068UF 20% 250VAC	C3AB,5AB
CA-422002-10	CAP MPOLY 0.22UF 10% 250V	C10
CA-422002-10	CAP MPOLY 0.22UF 10% 250V	C22A,B
CA-547002-10	4.7UF,16V,20% RADIAL NON-POLAR	E1AB
CA-547003-10	CAP LYTIC RL 4.7UF 10% 160V	E8
CA-647002-10	CAP LYTIC RL 47UF 20% 50V	E9
CA-722002-10	CAP LYTIC RL 220UF 20% 25V	E2AB,3AB
CA-833001-00	CAP LYTIC 3300UF 100V 20%	E4AB-7AB
CH-140208-LX	1200/1400/1700 HEATSINK, FAB.	
CO-000008-IC	8 PIN IC SOCKET	IC1ab
CO-350432-AP	HEADER PCB 3 X 3 AMP TYPE	J101
HW-000001-FC	FUSE CLIPS	F1ab
HW-060100-PS	STUD PEM 6-32 X 0.625"	

## USA 900 Main Board Assembly (con't)

HW-060405-SP	SPACER RND AL .25"OD X 5/32"L	
HW-060600-SO	STANDOFF 1/4" HEX AL 6-32 M/F	
IC-000021-00	IC LIN DUAL OP AMP 5532	IC1A,B
LB-140225-AX	LABEL, UL. FUSE CAUTION	
MS-000048-HS	HEAT SINK, ISOL TO-220	REF:Q1A,B, REF:Q2A,B
MS-120250-FU	12A 250V, FUSE	F1ab
NW-060500-KP	#6-32 KEPS NUT	
PC-140044-LX	PCB FAB, MAIN PCB 1200/1400	
PL-000000-AF	ADHESIVE FEET	
PL-903125-SP	SPACER,ROUND,NYLON,0.125"L	D1ab,2ab, L1ab,R38ab
PL-905156-SP	SPACER,ROUND,NYLON,#6,0.155"L	REF: LD3
PL-905325-SP	SPACER, ROUND,NYLON,#6,0.325"L	LD1ab,2
PL-909235-SP	HOLDER,LED,90 DEGREE,NYLON	LD1ab,2
PT-110000-AT	RES VAR IT 100 20% 0.15W CARB	TR3ab
PT-250000-AT	RES VAR IT 5K 20% 0.15W CARB	TR4ab,5ab
PT-422000-AT	RES VAR IT 220K 20% 0.5W CERM	TR2ab
QD-000004-TX	XISTOR NPN TO-92+60V 0.5A 1W	Q12
QD-000032-QD	XISTOR NPN TO-3 200V 16A	Q7AB-10AB
QD-000033-QD	XISTOR PNP TO-3 200V 16A	Q3AB-6AB
QD-000045-00	DIODE BRIDGE RECT DIP 200V 1A	B2AB
QD-000076-00	XISTOR NPN TO-220 250V	Q1A,B
QD-000077-00	XISTOR PNP TO-220 250V	Q2A,B
QD-000134-LG	LED GRN T-1 3/4	LD2
QD-000134-LR	LED RED T-1 3/4	LD1ab
QD-0003.9-ZT	DIODE ZNR 3.9V TESTED	Z3ab
QD-0004.7-ZT	DIODE ZNR 4.7V TESTED	Z4ab
QD-001340-LR	LED RED T-1 3/4 VOLTAGE REF	LD3
QD-004004-DX	DIODE RECT DO41 400V 1A	D11ab D4ab-7ab D8,10ab, Z1ab,2ab, Z5
QD-004744-ZA	DIODE ZNR 15V 5% 1W 1N4744A	
QD-004934-DX	DIODE RECT DO41 FAST 100V 1A	D1ab,2ab
QD-008599-TX	XISTOR PNP TO-92 60V 0.5A	Q11
QD-400400-BX	DIODE BRIDGE RECT 400V 40A	B1ab
RE-.02205-FW	RES WW 0.22 10% 3W	R23ab-30ab
RE-.56005-EM	RES MOFP 5.6 5% 2W	R31ab
RE-.68005-DM	RES MOFP 6.8 5% 1W	R15ab,16ab
RE-000009-PT	RES PTC 90C 0.1K MAX COLD	PTC
RE-000050-NR	THERMISTOR NTC 50 OHM	R38ab
RE-000140-NR	THERMISTOR NTC 9A CUR LIM	R37
RE-001005-EM	RES MOFP 10 5% 2W	R32ab
RE-002205-DM	RES MOFP 22 5% 1W	R17ab,18ab
RE-015001-BM	RES MF 150 1% 1/4W	R14ab,36ab
RE-016501-BM	RES MF 165 1% 1/4W	R5ab
RE-025010-NW	RES WW 250 10% 15W	R42
RE-045010-HW	RES WW 450 10% 5W	R22ab
RE-075001-BM	RES MF 750 1% 1/4W	R10ab
RE-110005-BC	RES CF 1K 5% 1/4W	R12ab,13ab
RE-130005-EM	RES MOFP 3K 5% 2W	R20ab,21ab
RE-147005-BC	RES CF 4.7K 5% 1/4W	R11ab

## USA 900 Main Board Assembly (con't)

Part Number	Description	Reference
RE-162005-CC	RES CF 6.2K 5% 1/2W	R19
RE-168005-BC	RES CF 6.8K 5% 1/4W	R34,41
RE-210001-BM	RES MF 10.0K 1% 1/4W	R1ab-4ab
RE-210002-CM	RES MF 10.0K 2% 1/2W	R6ab
RE-210005-EM	RES MOFP 10K 5% 2W	R39
RE-247005-CC	RES CF 47K 5% 1/2W	R9ab
RE-247005-DM	RES MOFP 47K 5% 1W	R35
		R7AB,8AB,
		R40
RE-310005-BC	RES CF 100K 5% 1/4W	R40
RE-318005-BC	RES CF 180K 5% 1/4W	R33
SC-061041-SP	#6 X 1/4" "A" P/P W/SCRAPING	PTC,SW2
SC-062050-PP	#6 X 5/16" "B" P/P ZINC	
SW-000055-TS	55C THERMAL CUT-IN SWITCH	SW2
SW-000151-SW	SWITCH, SLIDE, SPDT	SW1
WC-0.3022-JW	.3" JUMPER, WHITE, 22 GA SLD	W3,8
WC-0.6022-JW	.6" JUMPER, WHITE, 22 GA, SLD	W2,9,19,28
WC-0.9022-JW	.9" JUMPER, WHITE, 22 GA, SLD	W1,4,15,
		W21,22,29,
		W30,31
WC-001102-SQ	INSUL. SLEEVE QSC 1102,.6",CLR	PTC
WC-001103-SQ	INSUL SLEEVE 1103,.875",CLEAR	REF: SW2
WC-1.2518-JW	1.25" JUMPER, WHITE 18 GA, SLD	W23
WC-1.5022-JW	1.5" JUMPER, WHITE, 22 GA, SLD	W11,12,16,
		W17,18,20
		W5,6,7,10,
WC-2.5018-JW	2.5" JUMPER, WHT, 18 GA, SLD	W13,14,24,
		W25,26,27
XF-200016-CR	INDUCTOR 2UH 18AWG VERT MNT	L1ab

## USA 900 Chassis Assembly

Part Number	Description	Reference
CH-001850-00	USA400/900/SE185/425 FACEPLATE	
CH-140101-00	CHASSIS, SA/USA/SER.1 3 SPACE	
CH-140210-BX	1400 KNOB FABRICATION	
CO-000011-00	CONN DUAL 5-WAY BIND RD/BLK R	
CO-000012-00	CONN DUAL 5-WAY BIND RD/BLK L	
LB-000052-00	LABEL, cUL APPROVAL	
LB-000138-00	LABEL, INPUT, USA 2 SERIES	
LB-000142-00	LABEL, FACEPLATE USA 900 (DOM)	
LB-140102-00	LABEL OUTPUT SLC	
MS-000069-00	FAN ASSY, 1400	
NW-040422-SW	TOSHIBA SHOULDER WASHER	
NW-060400-HN	#6-32 X 1/4" HEX NUT	
PL-000001-SR	HEYCO 6W-1 STRAIN RELIEF 16/3	
PL-000003-CP	AC CORD PROTECTOR	
SC-030000-SC	3mm x 8mm,P/P,TYPE 1,BLK. OX.	
SC-060030-PU	#6-32 X 3/16 P/P UNDERCUT ZINC	
SC-060081-PP	#6-32 X 1/2" P/P BLACK	
SC-061081-PP	#6 X 3/8" "B" P/P ZINC	
SC-081101-SP	#8-18 X 5/8", TYPE 1 P/P BLACK	
SC-100061-PS	SCREW 10-32X3/8" BLK P/P SEMS	

## USA 900 Chassis Assembly (con't)

SW-000010-CB	10A. CIRCUIT BREAKER
SW-000016-SW	SPST SNAP IN POWER SWITCH
WC-000034-00	WIRE ASSY, 4.5", BLACK
WC-001004-CX	QSC AC CORD 1004, 72", BLACK
WC-001005-AX	QSC WIRE 1005, 2.5", BLACK
WP-001325-00	PCB ASSY,JCKPLN,USA 2 SERIES
WP-140044-TD	1400 MAIN DOM
XF-001401-BX	1400 POWER XFMR 120/230V

## USA 1310 Ch.1 Main Board Assembly

Part Number	Description	Reference
CA-027001-10	CAP SM 27PF 10% 500V	C4
CA-047001-10	CAP CER 47PF 10% 100V NPO	C1,2
CA-210050-CP	CAP MYLAR .001UF 5% 50V	C12
CA-215002-10	CAP MYLAR .0015UF 5% 200V	C7
CA-222002-10	.0022UF,200V,10%,MYLAR	C8
CA-333100-BP	CAP MYLAR .033UF 10% 100V	C9
CA-347400-BP	CAP MYLAR .047UF 10% 400V	C13-16
CA-410250-AS	CAP SURGE .1UF 20% 250VAC	C10
CA-412001-10	CAP MYLAR .12UF 5% 100V	C3
CA-610002-10	10UF,35V,20%,RADIAL ELECT	E4
CA-647001-10	CAP LYTIC RL 47UF 10% 10V NP	E1
CA-647002-10	CAP LYTIC RL 47UF 20% 50V	E5
CA-722001-10	CAP LYTIC RL 220UF 20% 10V NP	E6
CA-722002-10	CAP LYTIC RL 220UF 20% 25V	E2,3
CA-822100-BE	CAP LYTIC RL 2200UF 20% 100V	E7-14
CH-140208-LX	1200/1400/1700 HEATSINK, FAB.	
CO-000008-IC	8 PIN IC SOCKET	REF: IC1
CO-350432-AP	HEADER PCB 3 X 3 AMP TYPE	P2
CO-641119-AH	8 PIN .156"/C HEADER	P1
HW-000001-FC	FUSE CLIPS	REF: F1,2
HW-060100-PS	STUD PEM 6-32 X 0.625"	P
HW-060405-SP	SPACER RND AL .25"OD X 5/32"L	P
HW-060600-SO	STANDOFF 1/4" HEX AL 6-32 M/F	S
IC-000021-00	IC LIN DUAL OP AMP 5532	IC1
MS-000044-FT	FOAM ADHESIVE TAPE 1/8X 1/2 X1	PCB
MS-000057-00	CLIP HEATSINK TO220	REF:Q1A,2A
MS-000061-00	HEATSINK TO-220	REF:Q1A,2A
MS-150250-FU	15A, 250V, FUSE	F1,2
NW-060500-KP	#6-32 KEPS NUT	
PC-000001-00	1700 MAIN PCB ASSY CHANNEL 1	
PL-000000-AF	ADHESIVE FEET	PCB
PL-000077-00	INSULATOR TO-218 .725 X .950	REF:Q1A,2A
PL-903125-SP	SPACER,ROUND,NYLON,0.125"L	R54
		REF: D5,6,
PL-905100-SP	SPACER,ROUND,NYLON,#6,0.100"L	REF: L1
PL-905156-SP	SPACER,ROUND,NYLON,#6,0.155"L	REF: LD3
PL-905200-SP	SPACER,ROUND,NYLON,#6,0.200"L	REF: LD1,2
PL-909235-SP	HOLDER,LED,90 DEGREE,NYLON	REF: LD1,2
PT-110000-AT	RES VAR IT 100 20% 0.15W CARB	TR1,2
PT-250000-AT	RES VAR IT 5K 20% 0.15W CARB	TR3
QD-000004-TX	XISTOR NPN TO-92+60V 0.5A 1W	Q21
QD-000024-QD	DIODE ZNR 6.2V 5% TESTED	Z5



## USA 1310 Ch.1 Main Board Assembly (con't)

Part Number	Description	Reference
QD-000032-QD	XISTOR NPN TO-3 200V 16A	Q11-Q18
QD-000033-QD	XISTOR PNP TO-3 200V 16A	Q3-Q10
QD-000045-00	DIODE BRIDGE RECT DIP 200V 1A	B1,2
QD-000056-10	XISTOR PNP TO-92 60V 0.5A	Q19,20
QD-000076-00	XISTOR NPN TO-220 250V	Q1A
QD-000077-00	XISTOR PNP TO-220 250V	Q2A
QD-000134-LR	LED RED T-1 3/4	LD2
QD-000134-LX	LED RED/GRN T-1 3/4	LD1
QD-0003.9-ZT	DIODE ZNR 3.9V TESTED	Z4
QD-0004.7-ZT	DIODE ZNR 4.7V TESTED	Z1
QD-001340-LR	LED RED T-1 3/4 VOLTAGE REF	LD3
QD-004004-DX	DIODE RECT DO41 400V 1A	D1,2,D7-13
QD-004744-ZA	DIODE ZNR 15V 5% 1W 1N4744A	Z2,3
QD-004753-ZT	DIODE ZNR 36V 5% 1W 1N4753A	Z6
QD-004934-DX	DIODE RECT DO41 FAST 100V 1A	D5,6
QD-005402-DX	DIODE RECT DO27 200V 3A	D3,4
QD-400400-BX	DIODE BRIDGE RECT 400V 40A	B3
RE-.04705-FW	RES WW 0.47 10% 3W	R33-48
RE-.56005-EM	RES MOFP 5.6 5% 2W	R13A
		R26,12A,
RE-000009-PT	RES PTC 90C 0.1K MAX COLD	R56
RE-000050-NR	THERMISTOR NTC 50 OHM	R54
RE-001005-EM	RES MOFP 10 5% 2W	R27,28
RE-002205-DM	RES MOFP 22 5% 1W	R16,17
RE-004705-BC	RES CF 47 5% 1/4W	R55
RE-015005-BC	RES CF 150 5% 1/4W	R25
RE-025010-NW	RES WW 250 10% 15W	R50
RE-033201-BM	RES MF 332 1% 1/4W	R7
RE-045010-HW	RES WW 450 10% 5W	R31
RE-068010-HW	RES WW 680 10% 5W	R49
RE-110005-BC	RES CF 1K 5% 1/4W	R5,14,15
RE-115005-BC	RES CF 1.5K 5% 1/4W	R24
RE-116201-BM	RES MF 1.62K 1% 1/4W	R32
RE-136001-00	RES MOFP 3.6K 5% 5W	R52,53
RE-147005-BC	RES CF 4.7K 5% 1/4W	R6
RE-175005-EM	RES MOFP 7.5K 5% 2W	R29
RE-210001-BM	RES MF 10.0K 1% 1/4W	R1-4
RE-210005-EM	RES MOFP 10K 5% 2W	R30
RE-221001-CM	RES MF 21.0K 1% 1/2W	R9
RE-247005-CC	RES CF 47K 5% 1/2W	R21
RE-275001-BM	RES MF 75.0K 1% 1/4W	R8
RE-310005-BC	RES CF 100K 5% 1/4W	R22,23
RE-333005-BC	RES CF 330K 5% 1/4W	R19,20
SC-061041-SP	#6 X 1/4" "A" P/P W/SCRAPING	R56
		REF:SW1,
SC-062050-PP	#6 X 5/16" "B" P/P ZINC	REF:Q3-Q18
SW-000013-RY	RELAY, SPDT, 15A, 24VDC	K1
SW-000055-TS	55C THERMAL CUT-IN SWITCH	SW1
WC-0.5018-JW	.5" JUMPER, WHT., 18 GA, SOLID	W5,7
WC-0.6022-JW	.6" JUMPER, WHITE, 22 GA, SLD	W10,11
WC-001102-SQ	INSUL. SLEEVE QSC 1102,.6",CLR	REF:R56
WC-001103-SQ	INSUL SLEEVE 1103,.875",CLEAR	REF:SW1

## USA 1310 Ch.1 Main Board Assembly (con't)

WC-2.5018-JW	2.5" JUMPER, WHT, 18 GA, SLD	W1
XF-200014-CR	INDUCTOR 2UH 14AWG VERT MNT	L1

## USA 1310 Ch.2 Main Board Assembly

Part Number	Description	Reference
CA-027001-10	CAP SM 27PF 10% 500V	C4
CA-047001-10	CAP CER 47PF 10% 100V NPO	C1,2
CA-210050-CP	CAP MYLAR .001UF 5% 50V	C12
CA-215002-10	CAP MYLAR .0015UF 5% 200V	C7
CA-222002-10	.0022UF,200V,10%,MYLAR	C8
CA-333100-BP	CAP MYLAR .033UF 10% 100V	C9
CA-347400-BP	CAP MYLAR .047UF 10% 400V	C17-20
CA-368250-AS	CAP SURGE .068UF 20% 250VAC	C11
CA-410250-AS	CAP SURGE .1UF 20% 250VAC	C10
CA-412001-10	CAP MYLAR .12UF 5% 100V	C3
CA-610002-10	10UF,35V,20%,RADIAL ELECT	E4
CA-647001-10	CAP LYTIC RL 47UF 10% 10V NP	E1
CA-647002-10	CAP LYTIC RL 47UF 20% 50V	E5
CA-722001-10	CAP LYTIC RL 220UF 20% 10V NP	E6
CA-722002-10	CAP LYTIC RL 220UF 20% 25V	E2,3
CA-822100-BE	CAP LYTIC RL 2200UF 20% 100V	E7-14
CH-140208-LX	1200/1400/1700 HEATSINK, FAB.	
CO-000008-IC	8 PIN IC SOCKET	REF: IC1
CO-350432-AP	HEADER PCB 3 X 3 AMP TYPE	P2
CO-641119-AH	8 PIN .156"/C HEADER	P1
HW-000001-FC	FUSE CLIPS	REF: F1,2
HW-060100-PS	STUD PEM 6-32 X 0.625"	P
HW-060405-SP	SPACER RND AL .25"OD X 5/32"L	P
HW-060600-SO	STANDOFF 1/4" HEX AL 6-32 M/F	S
IC-000021-00	IC LIN DUAL OP AMP 5532	IC1
MS-000044-FT	FOAM ADHESIVE TAPE 1/8X 1/2 X1	PCB
MS-000057-00	CLIP HEATSINK TO220	REF:Q1A,2A
MS-000061-00	HEATSINK TO-220	REF:Q1A,2A
MS-150250-FU	15A, 250V, FUSE	F1,2
NW-060500-KP	#6-32 KEPS NUT	
PC-000002-00	1700 MAIN PCB ASSY CHANNEL 2	
PL-000000-AF	ADHESIVE FEET	PCB
PL-000077-00	INSULATOR TO-218 .725 X .950	REF:Q1A,2A
PL-903125-SP	SPACER,ROUND,NYLON,0.125"L	R54
		REF: D5,6,
PL-905100-SP	SPACER,ROUND,NYLON,#6,0.100"L	REFI L1
PL-905156-SP	SPACER,ROUND,NYLON,#6,0.155"L	REF: LD3
PL-905200-SP	SPACER,ROUND,NYLON,#6,0.200"L	REF: LD1,2
PL-909235-SP	HOLDER,LED,90 DEGREE,NYLON	REF: LD1,2
PT-110000-AT	RES VAR IT 100 20% 0.15W CARB	TR1,2
PT-250000-AT	RES VAR IT 5K 20% 0.15W CARB	TR3
QD-000004-TX	XISTOR NPN TO-92+60V 0.5A 1W	Q21
QD-000024-QD	DIODE ZNR 6.2V 5% TESTED	Z5
QD-000032-QD	XISTOR NPN TO-3 200V 16A	Q11-Q18
QD-000033-QD	XISTOR PNP TO-3 200V 16A	Q3-Q10
QD-000045-00	DIODE BRIDGE RECT DIP 200V 1A	B1,2
QD-000056-10	XISTOR PNP TO-92 60V 0.5A	Q19,20
QD-000076-00	XISTOR NPN TO-220 250V	Q1A

## USA 1310 Ch.2 Main Board Assembly (con't)

Part Number	Description	Reference
QD-000077-00	XISTOR PNP TO-220 250V	Q2A
QD-000134-LR	LED RED T-1 3/4	LD2
QD-000134-LX	LED RED/GRN T-1 3/4	LD1
QD-0003.9-ZT	DIODE ZNR 3.9V TESTED	Z4
QD-0004.7-ZT	DIODE ZNR 4.7V TESTED	Z1
QD-001340-LR	LED RED T-1 3/4 VOLTAGE REF	LD3
QD-004004-DX	DIODE RECT DO41 400V 1A	D1,2,D7-13
QD-004744-ZA	DIODE ZNR 15V 5% 1W 1N4744A	Z2,3
QD-004753-ZT	DIODE ZNR 36V 5% 1W 1N4753A	Z6
QD-004934-DX	DIODE RECT DO41 FAST 100V 1A	D5,6
QD-005402-DX	DIODE RECT DO27 200V 3A	D3,4
QD-400400-BX	DIODE BRIDGE RECT 400V 40A	B3
RE-.04705-FW	RES WW 0.47 10% 3W	R33-48
RE-.56005-EM	RES MOFP 5.6 5% 2W	R13A
		R26,12A,
RE-000009-PT	RES PTC 90C 0.1K MAX COLD	R56
RE-000050-NR	THERMISTOR NTC 50 OHM	R54
RE-000100-NR	THERMISTOR NTC 20A CUR LIM	R57
RE-001005-EM	RES MOFP 10 5% 2W	R27,28
RE-002205-DM	RES MOFP 22 5% 1W	R16,17
RE-004705-BC	RES CF 47 5% 1/4W	R55
RE-015005-BC	RES CF 150 5% 1/4W	R25
RE-033201-BM	RES MF 332 1% 1/4W	R7
RE-045010-HW	RES WW 450 10% 5W	R31
RE-068010-HW	RES WW 680 10% 5W	R49
RE-110005-BC	RES CF 1K 5% 1/4W	R5,14,15
RE-115005-BC	RES CF 1.5K 5% 1/4W	R24
RE-116201-BM	RES MF 1.62K 1% 1/4W	R32
RE-136001-00	RES MOFP 3.6K 5% 5W	R52,53
RE-147005-BC	RES CF 4.7K 5% 1/4W	R6
RE-175005-EM	RES MOFP 7.5K 5% 2W	R29
RE-210001-BM	RES MF 10.0K 1% 1/4W	R1-4
RE-210005-EM	RES MOFP 10K 5% 2W	R30
RE-216501-CM	RES MF 16.5K 1% 1/2W	R51
RE-221001-CM	RES MF 21.0K 1% 1/2W	R9
RE-247005-CC	RES CF 47K 5% 1/2W	R21
RE-275001-BM	RES MF 75.0K 1% 1/4W	R8
RE-310005-BC	RES CF 100K 5% 1/4W	R22,23
RE-333005-BC	RES CF 330K 5% 1/4W	R19,20
SC-061041-SP	#6 X 1/4" "A" P/P W/SCRAPING	R56
		REF:SW1,
SC-062050-PP	#6 X 5/16" "B" P/P ZINC	REF:Q3-Q18
SW-000013-RY	RELAY, SPDT, 15A, 24VDC	K1
SW-000055-TS	55C THERMAL CUT-IN SWITCH	SW1
SW-000151-SW	SWITCH, SLIDE, SPDT	SW2
WC-0.5018-JW	.5" JUMPER, WHT., 18 GA, SOLID	W5,7
WC-001102-SQ	INSUL. SLEEVE QSC 1102,.6",CLR	REF:R56
WC-001103-SQ	INSUL SLEEVE 1103,.875",CLEAR	REF:SW1
WC-2.2522-JW	2.25" JUMPER, WHT, 22 GA, SLD	W10
WC-2.5018-JW	2.5" JUMPER, WHT, 18 GA, SLD	W1
XF-200014-CR	INDUCTOR 2UH 14AWG VERT MNT	L1

## USA 1310 Chassis Assembly

Part Number	Description	Reference
CH-006500-00	USA1310/SE650 FACEPLATE	
CH-140210-BX	1400 KNOB FABRICATION	
CH-170101-00	CHASSIS, SA/1700	
CH-170205-AX	1700 FAN SHROUD	
CO-000011-00	CONN DUAL 5-WAY BIND RD/BLK R	
CO-000012-00	CONN DUAL 5-WAY BIND RD/BLK L	
LB-000052-00	LABEL, cUL APPROVAL	
LB-000136-00	LABEL, FACEPLATE UPR USA 1310	
LB-000138-00	LABEL, INPUT, USA 2 SERIES	
LB-000144-00	LBL,FACEPLT LWR USA 1310 (DOM)	
LB-140102-00	LABEL OUTPUT SLC	
MS-000069-00	FAN ASSY, 1400	
NW-060400-HN	#6-32 X 1/4" HEX NUT	
PL-000003-CP	AC CORD PROTECTOR	
PL-000008-SR	HEYCO SR-7P-2 STR. RELIEF 14/3	
SC-030000-SC	3mm x 8mm,P/P,TYPE 1,BLK. OX.	
SC-060042-PP	#6-32 X 1/4" P/P BLACK,SEMS,IT	
SC-060081-PP	#6-32 X 1/2" P/P BLACK	
SC-061041-SP	#6 X 1/4" "A" P/P W/SCRAPING	
SC-081101-SP	#8-18 X 5/8", TYPE 1 P/P BLACK	
SC-100061-PS	SCREW 10-32X3/8" BLK P/P SEMS	
SW-000015-CB	15A. CIRCUIT BREAKER	
SW-000016-SW	SPST SNAP IN POWER SWITCH	
WC-000033-00	WIRE ASSY, 1.5", BLACK	
WC-001038-BX	1038 AC CORD, 88", BLACK	
WC-001048-TQ	WIRE ASSY,BLACK,5.75" L.	
WC-003090-00	WIRE ASSY, 10"LG, (RED/YEL)	
WC-003091-00	WIRE ASSY, 7"LG, (WHT/BLU)	
WP-001325-00	PCB ASSY,JCKPLN,USA 2 SERIES	
WP-170053-TD	1700 CHNL 1 DOM	
WP-170054-TD	1700 CHNL 2 DOM	
XF-001700-BX	XFMR P 1700 120/230V	

# USA Series Semiconductor Identification

## DRIVER TRANSISTORS

MJE15032 NPN / MJE15033 PNP

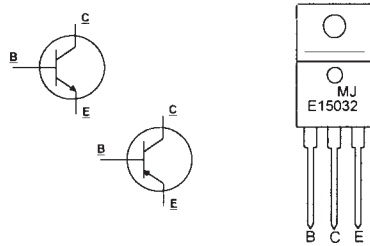

## POWER TRANSISTORS

MJ21194 NPN / MJ21193 PNP

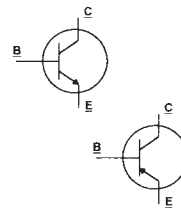

## OP-AMP

NE5532AN Dual Operational Amplifier

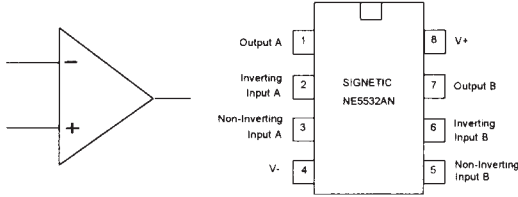

## SMALL SIGNAL TRANSISTORS

2N4410 NPN / MPS8599 PNP

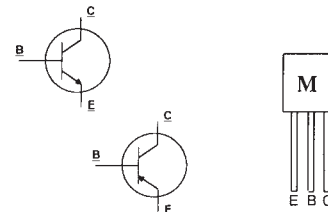

## OP-AMP

MC33178P Dual Operational Amplifier

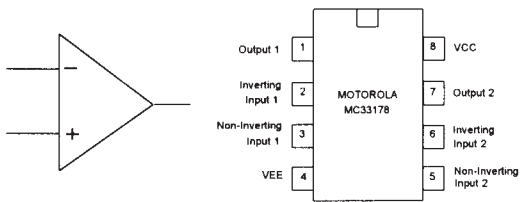

## OP-AMP

LM13600 Dual Transconductance

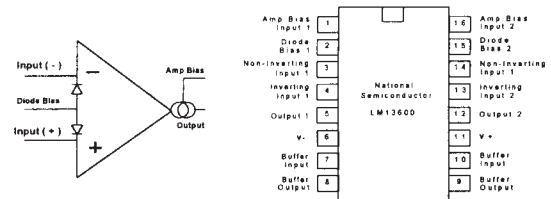

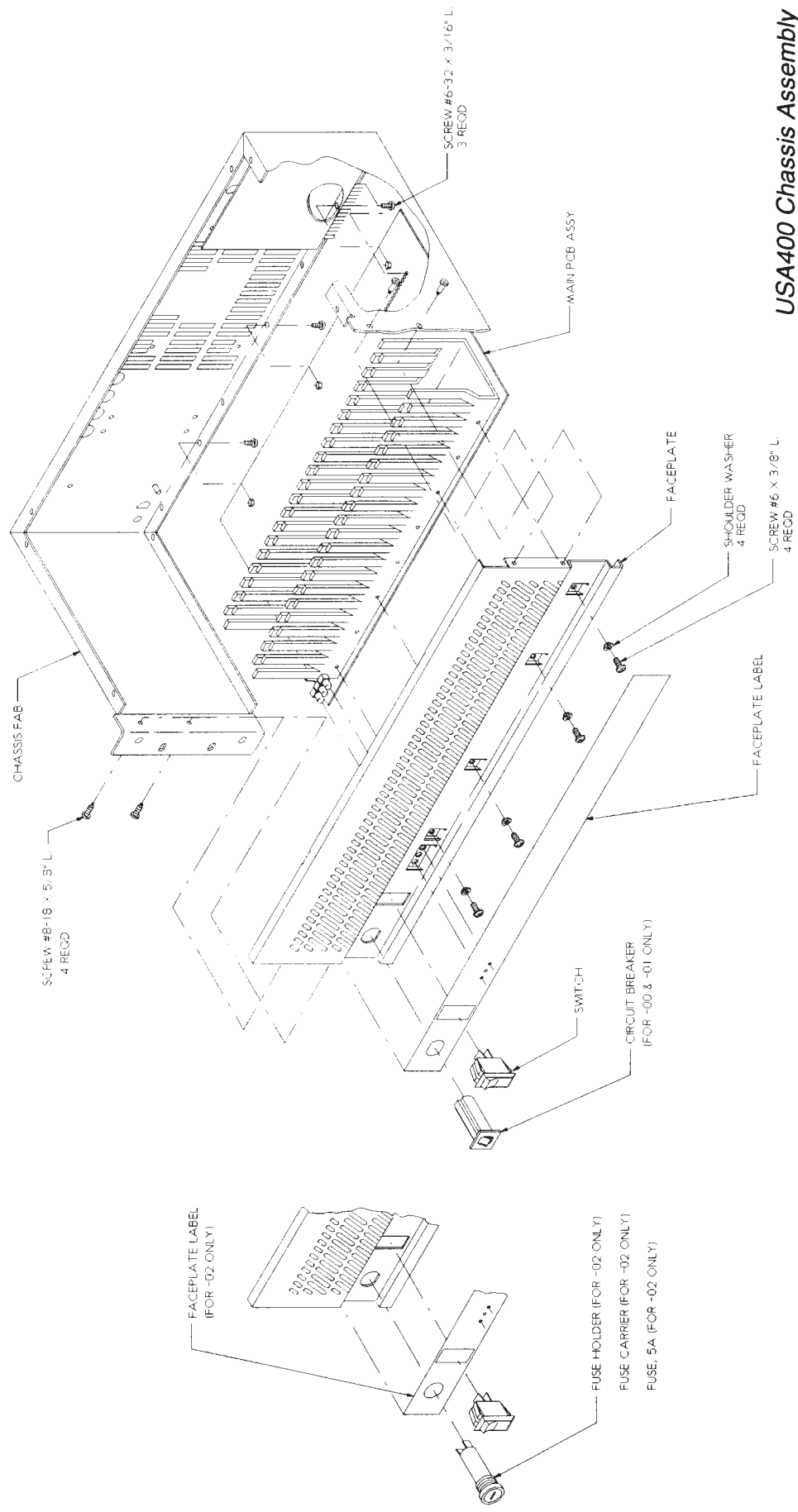

# USA400 Chassis Assembly

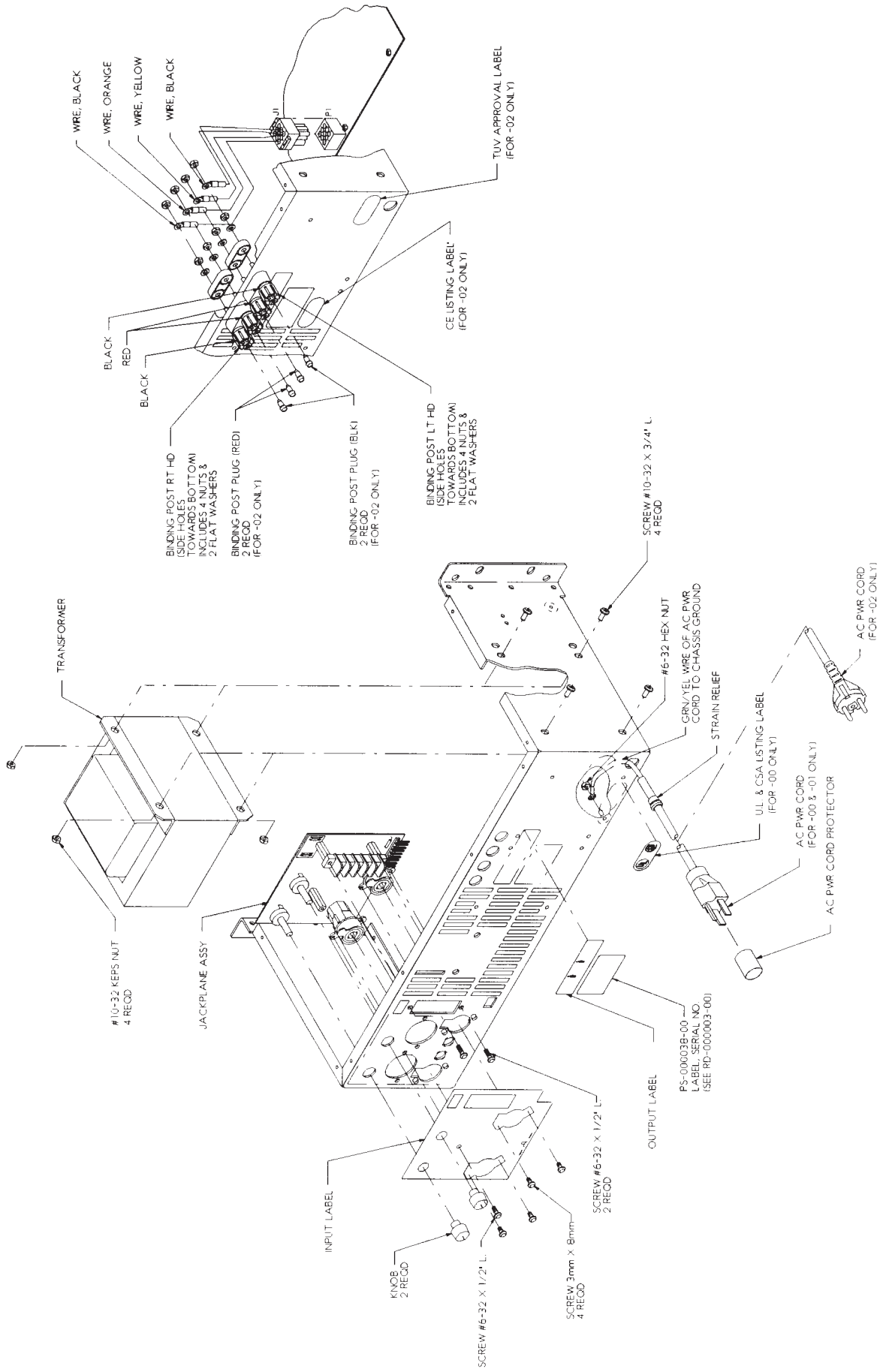

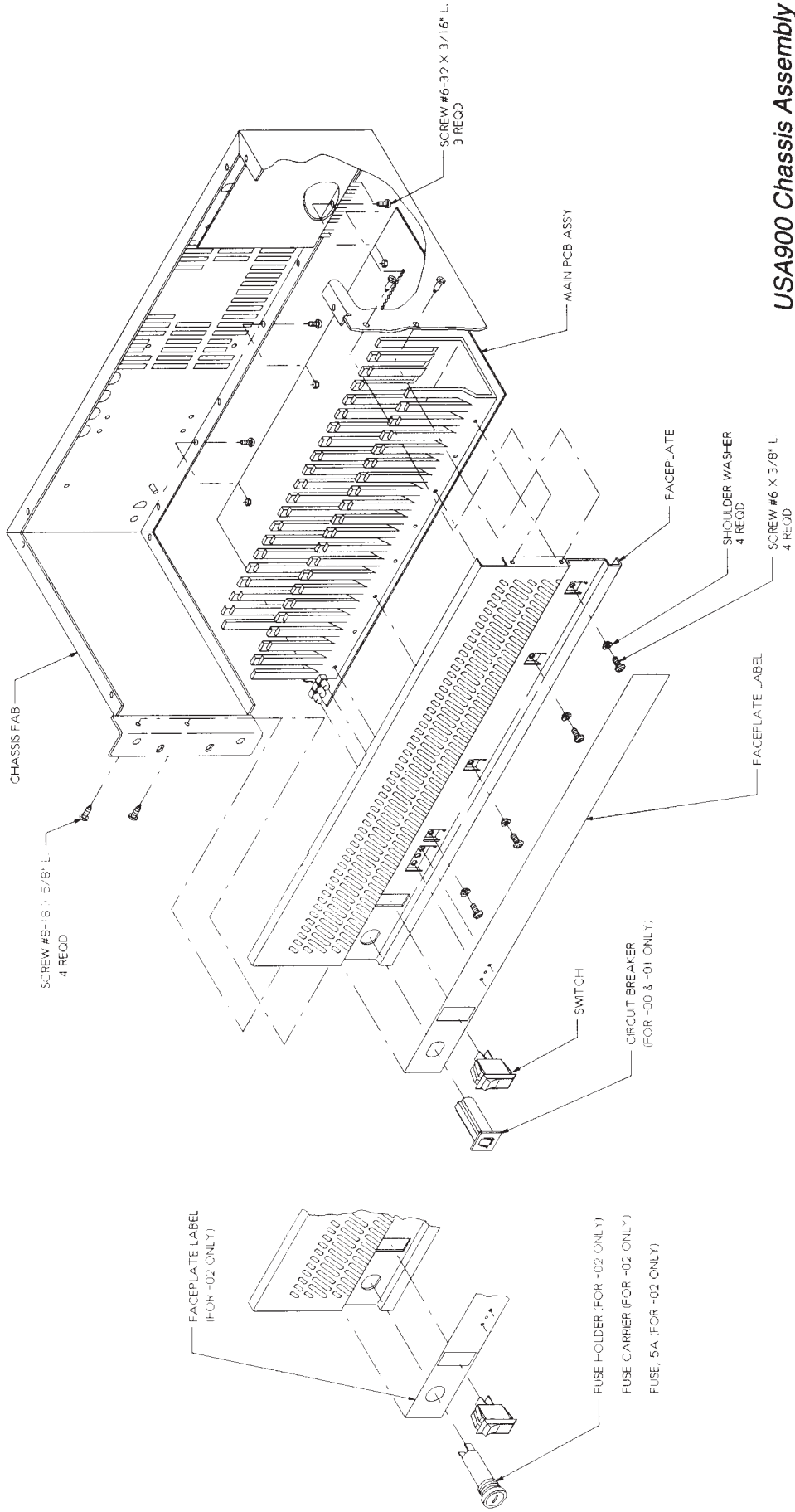

**USA900 Chassis Assembly**

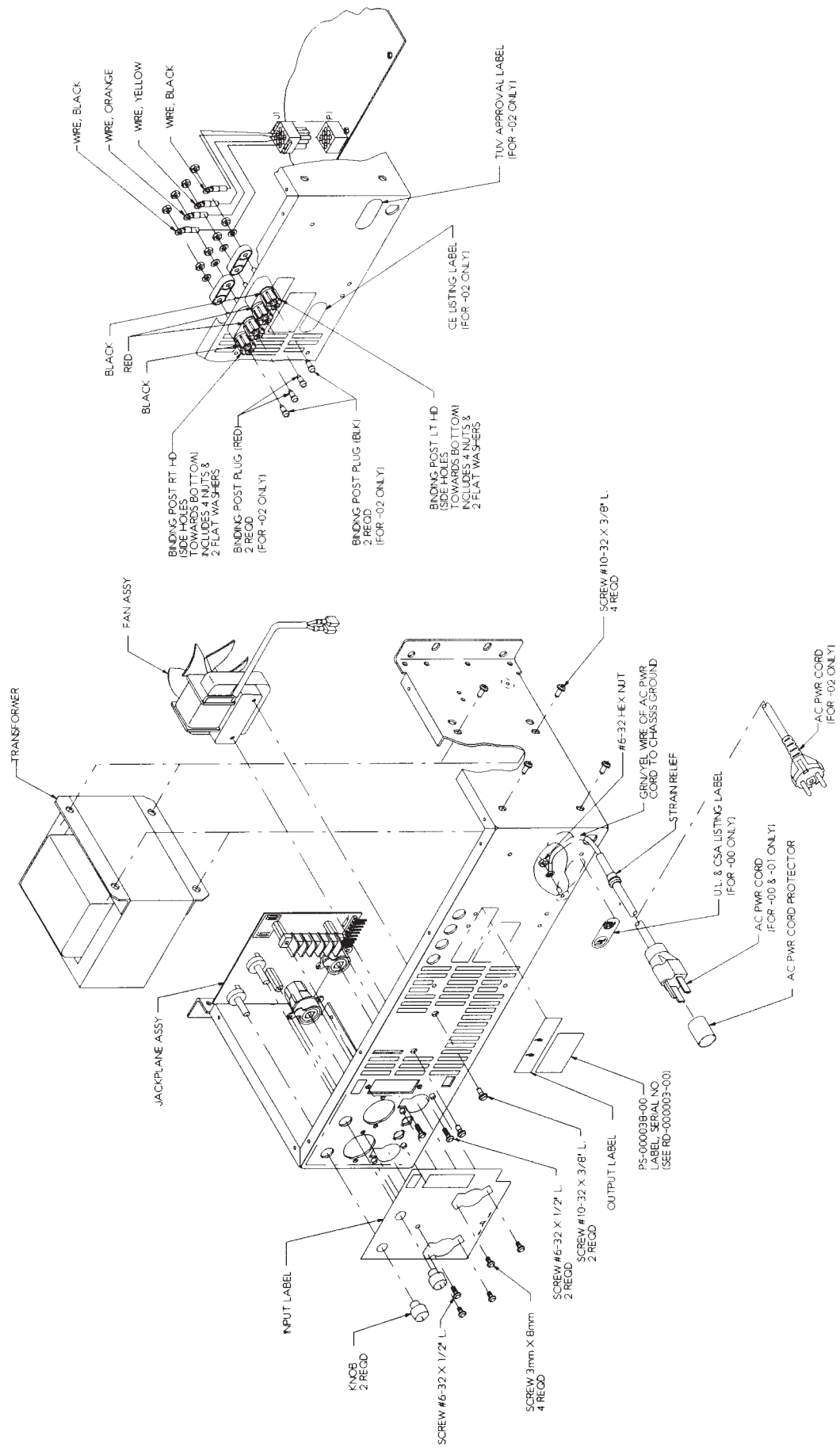

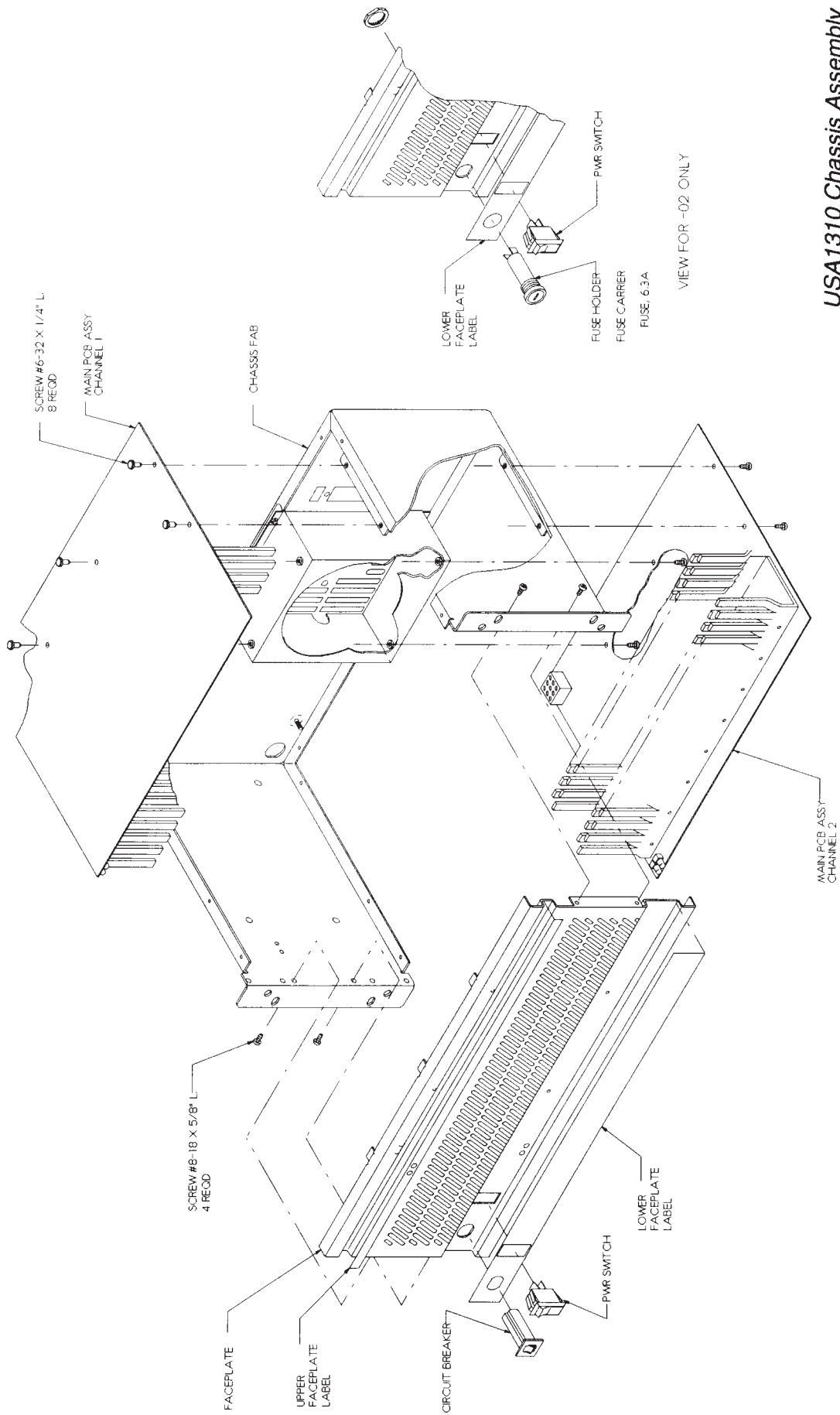

USA1310 Chassis Assembly





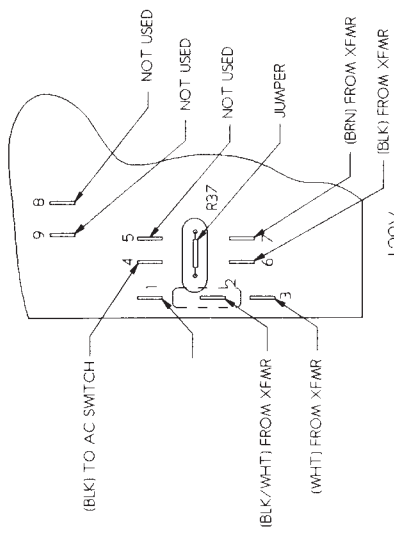

DETAIL A

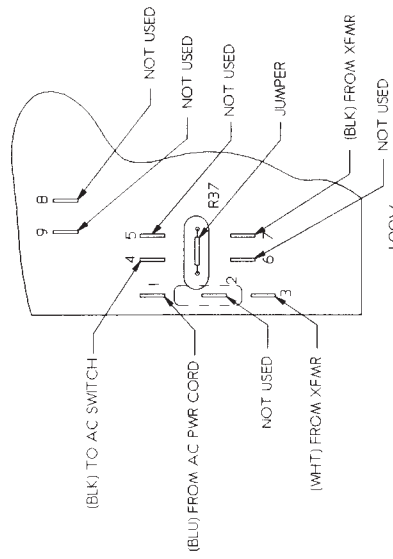

DETAIL A

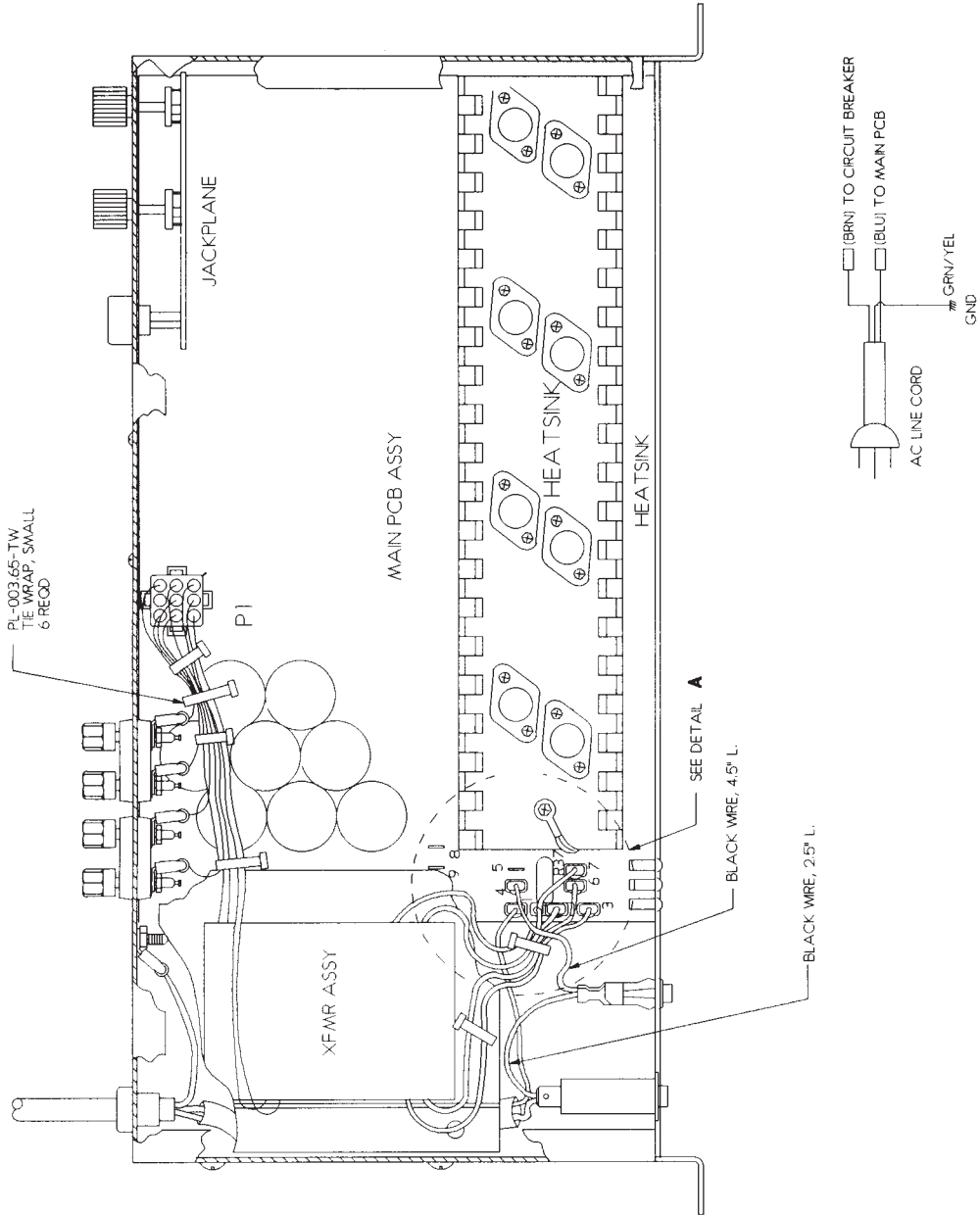
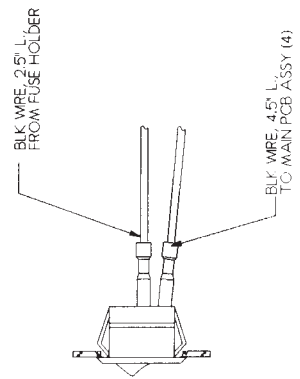

USA400 Wiring Diagram

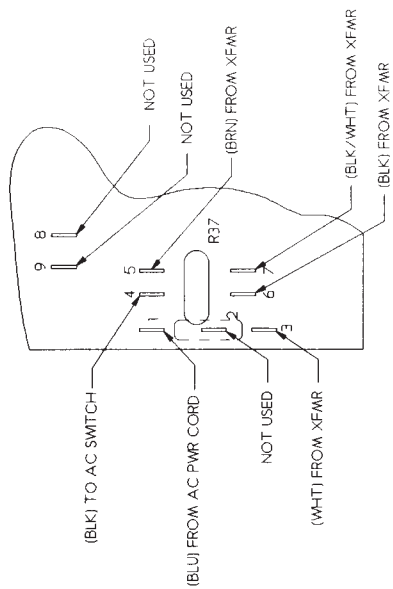

230V

DETAIL A

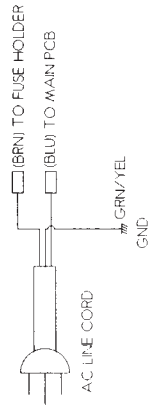
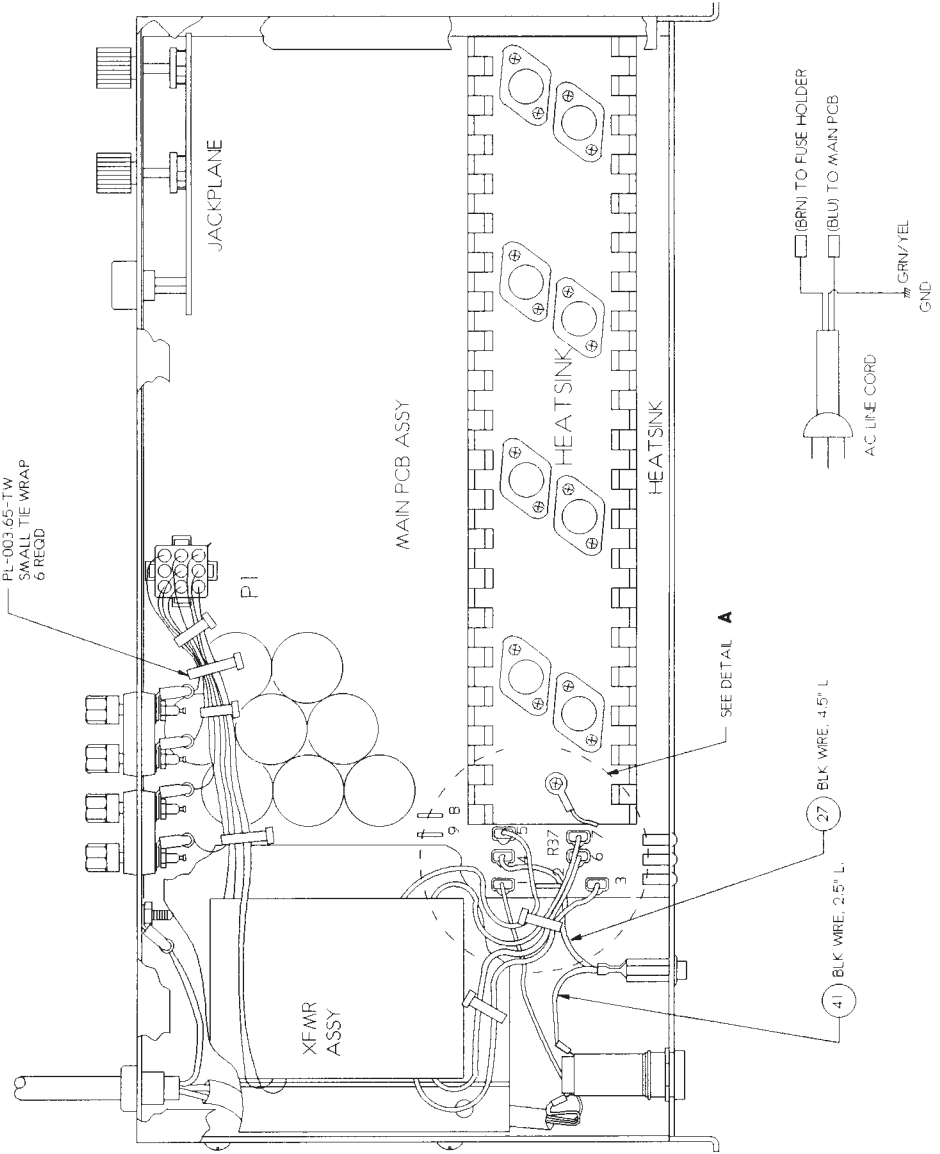
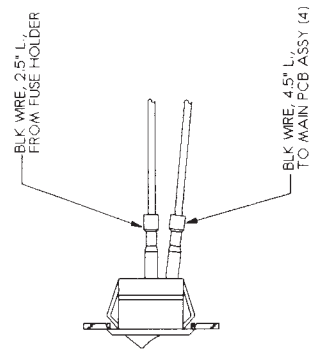

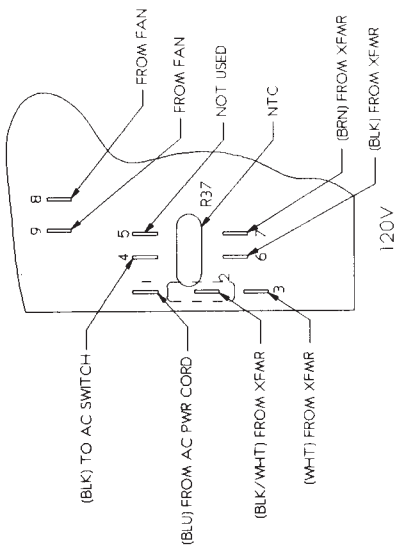

DETAIL A

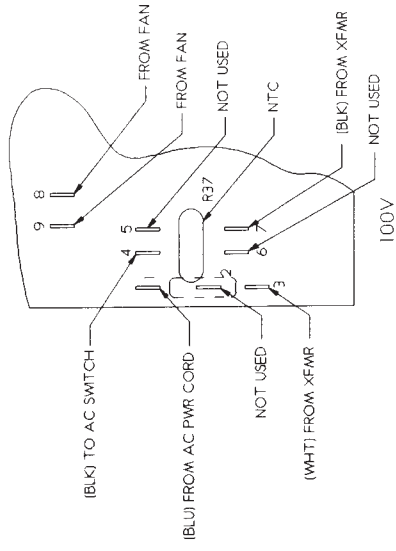

DETAIL A

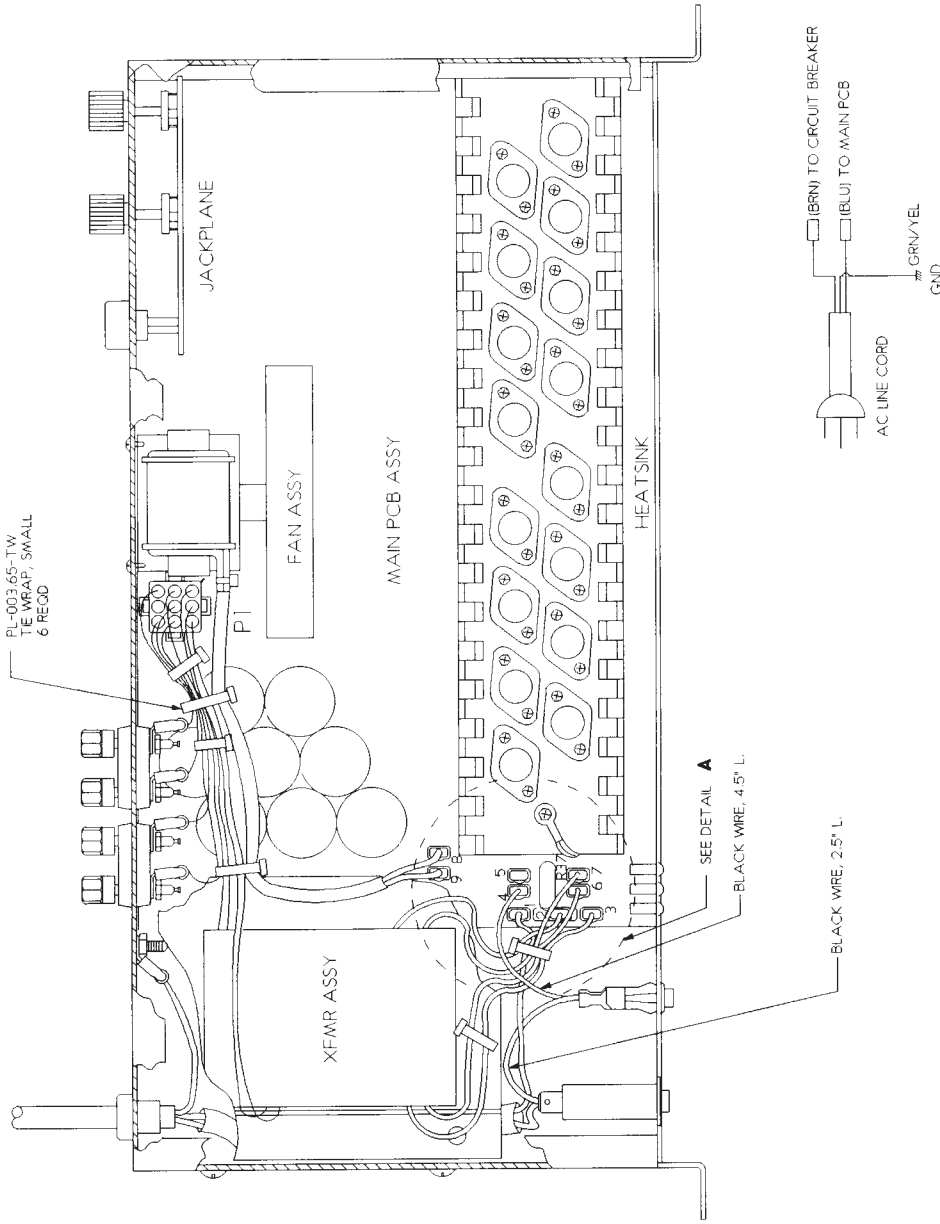
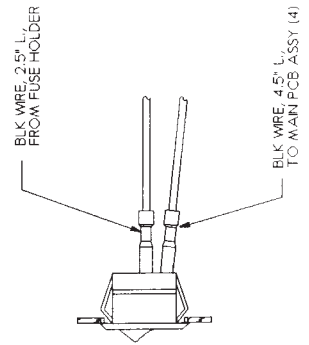

USA900 Wiring Diagram

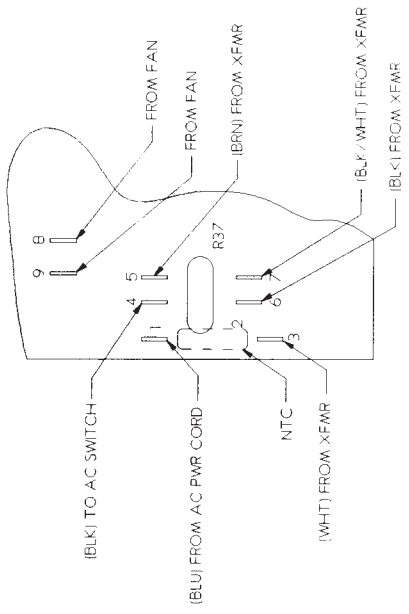

230V  
DETAIL A

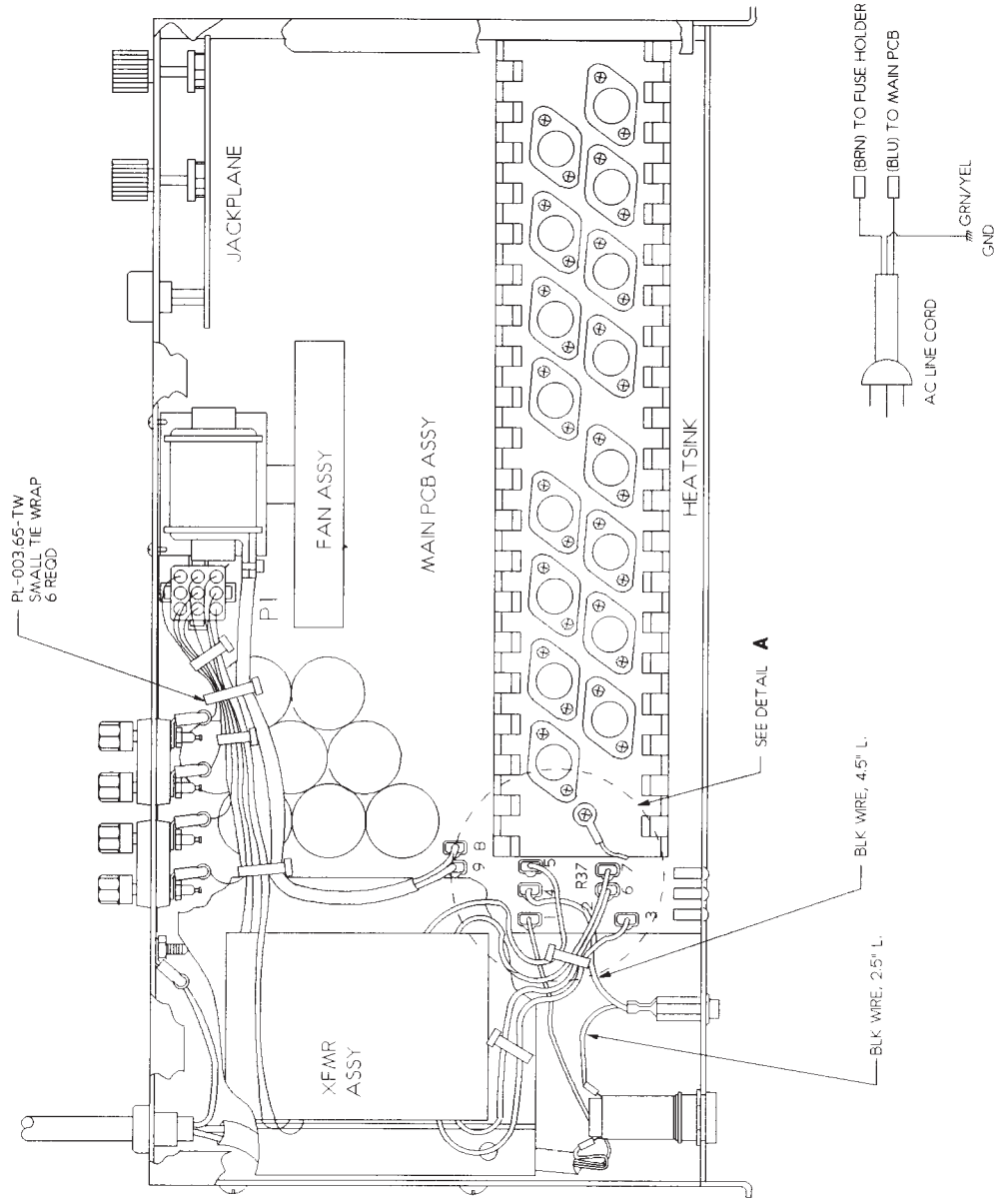
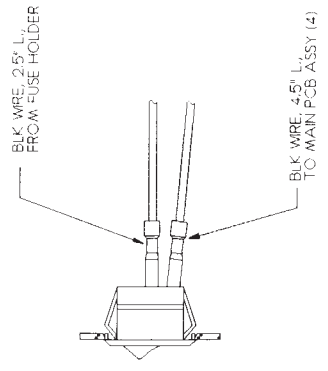

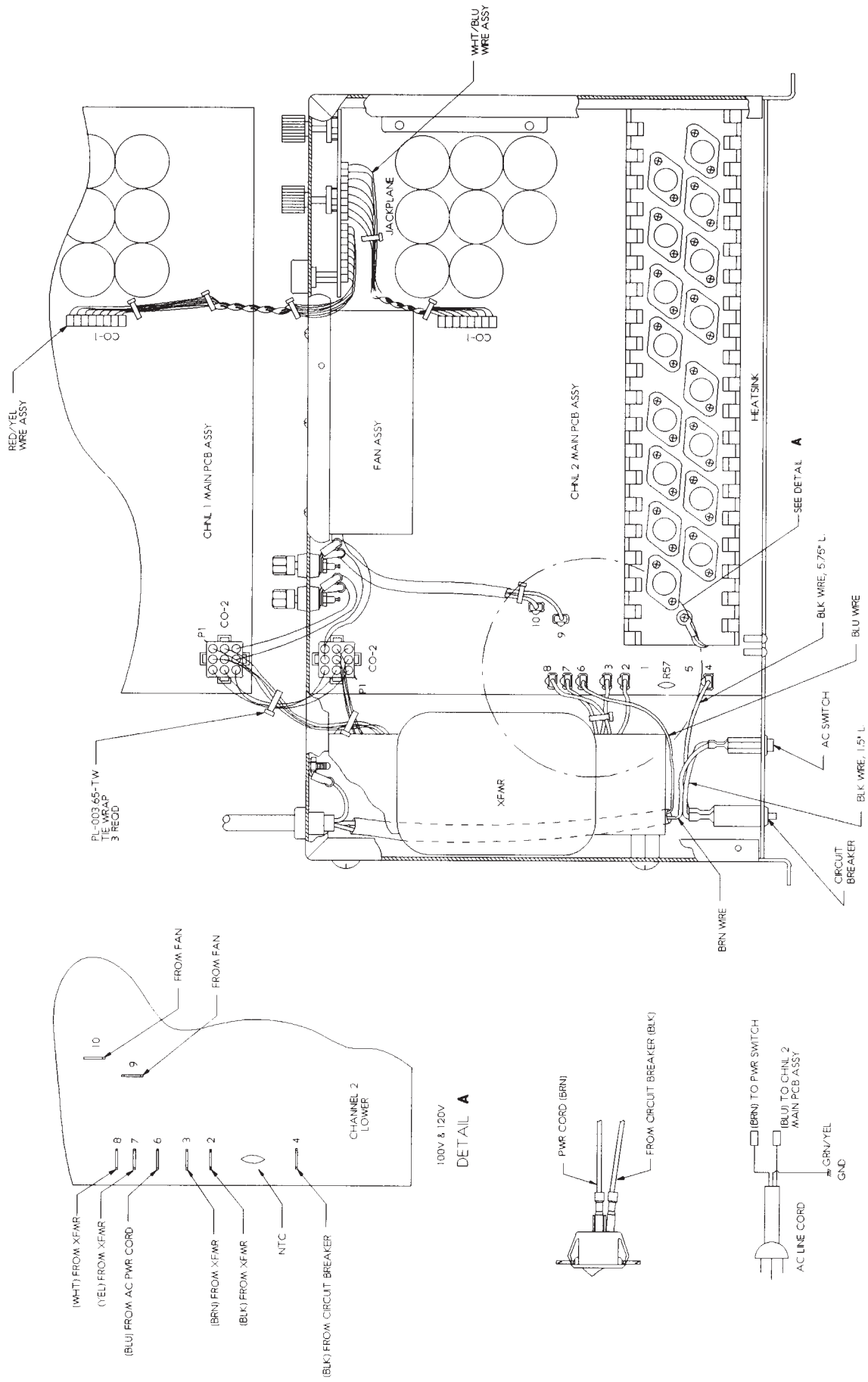

USA1310 Wiring Diagram

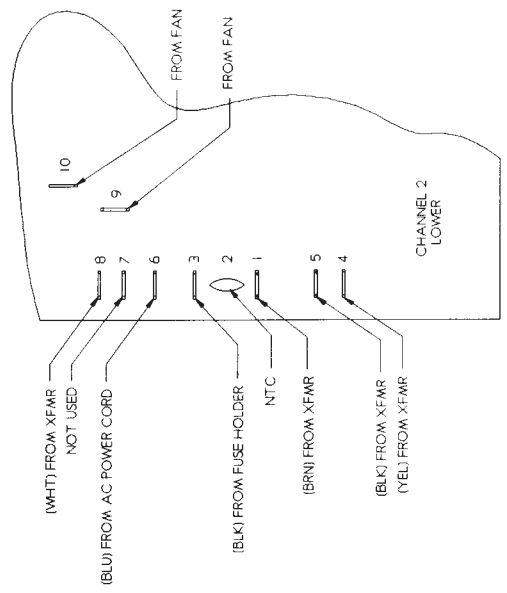
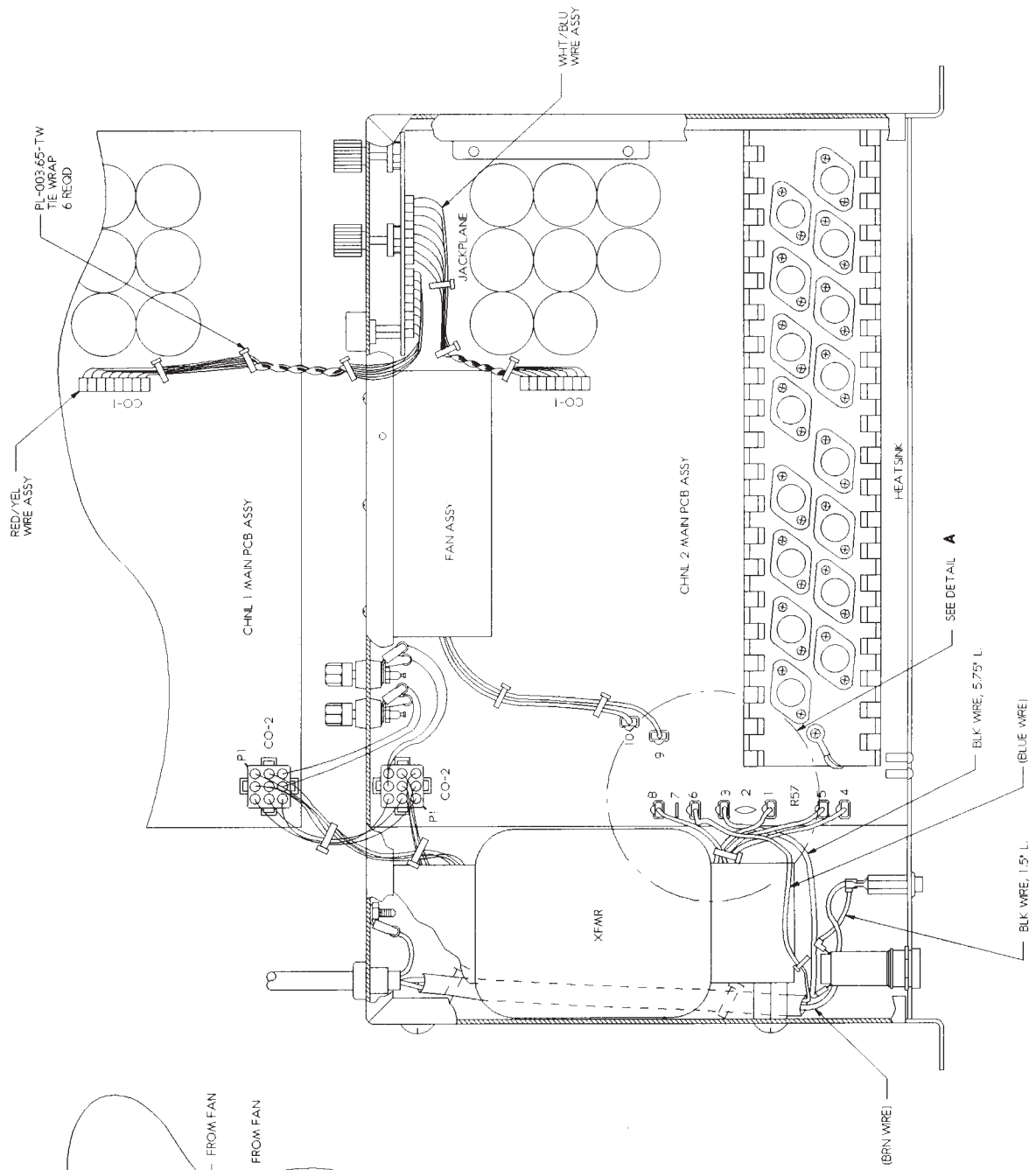

230V  
DETAIL A

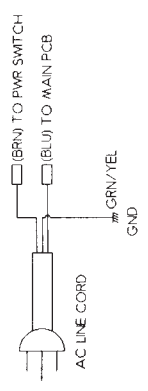
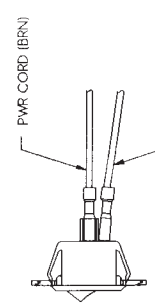





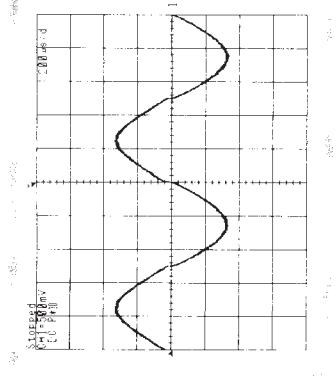
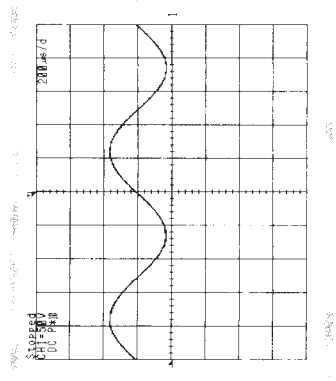
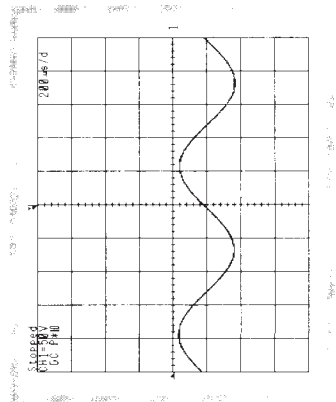

THIS DOCUMENT CONTAINS PROPRIETARY INFORMATION OF SONY AUDIO PRODUCTS. IT MAY NOT BE DISCLOSED, REPRODUCED OR USED WITHOUT EXPRESS WRITTEN CONSENT FROM SONY AUDIO PRODUCTS.

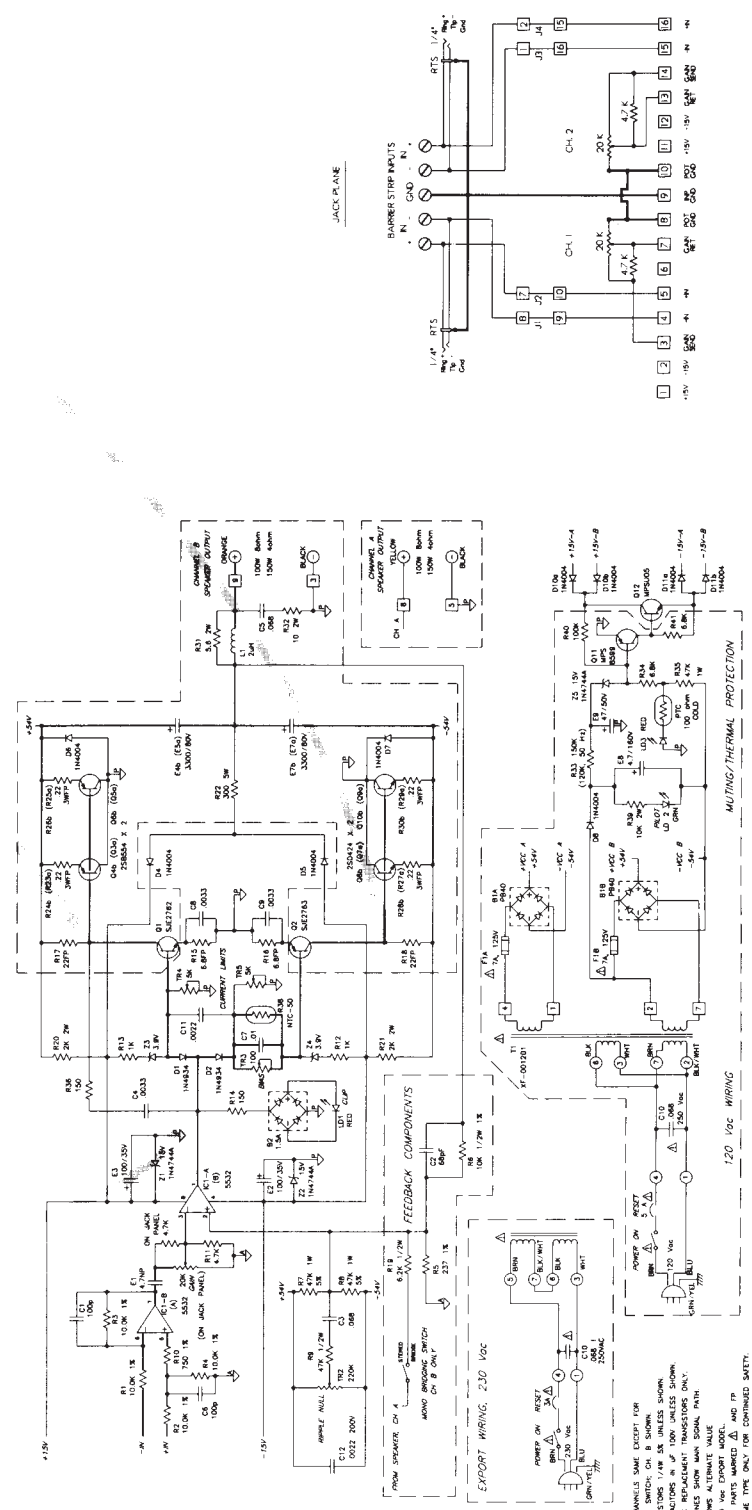

- NOTES
1. BOTH CHANNELS SAME EXCEPT FOR BRIDGING SWITCH; CH. B SHOWN.
  2. ALL RESISTORS 1/8" OR UNLESS SHOWN OTHERWISE.
  3. USE CAPACITORS UNLESS SHOWN OTHERWISE.
  4. HEAVY LINES SHOW MAIN SIGNAL PATH.
  5. R43 SHOWN ALTERNATE VALUE FOR 200 WATT EXPORT MODEL.
  6. WITH SAME TYPE ONLY FOR CONTINUED SAFETY.
  7. CONSTRUCTION AND WIRING OF 177W. PART NUMBER.
  8. I.C. IC1-A PINS 1, 2, 3 BECOME 7, 4, 5 ON CHANNEL A.
  9. AND IC1-B PINS 7, 4, 5 BECOME 1, 2, 3 ON CHANNEL A.

REF.	LAST USED	NOT USED
R1		
R2		
R3		
R4		
R5		
R6		
R7		
R8		
R9		
R10		
R11		
R12		
R13		
R14		
R15		
R16		
R17		
R18		
R19		
R20		
R21		
R22		
R23		
R24		
R25		
R26		
R27		
R28		
R29		
R30		
R31		
R32		
R33		
R34		
R35		
R36		
R37		
R38		
R39		
R40		
R41		
R42		
R43		
R44		
R45		
R46		
R47		
R48		
R49		
R50		
R51		
R52		
R53		
R54		
R55		
R56		
R57		
R58		
R59		
R60		
R61		
R62		
R63		
R64		
R65		
R66		
R67		
R68		
R69		
R70		
R71		
R72		
R73		
R74		
R75		
R76		
R77		
R78		
R79		
R80		
R81		
R82		
R83		
R84		
R85		
R86		
R87		
R88		
R89		
R90		
R91		
R92		
R93		
R94		
R95		
R96		
R97		
R98		
R99		
R100		
R101		
R102		
R103		
R104		
R105		
R106		
R107		
R108		
R109		
R110		
R111		
R112		
R113		
R114		
R115		
R116		
R117		
R118		
R119		
R120		
R121		
R122		
R123		
R124		
R125		
R126		
R127		
R128		
R129		
R130		
R131		
R132		
R133		
R134		
R135		
R136		
R137		
R138		
R139		
R140		
R141		
R142		
R143		
R144		
R145		
R146		
R147		
R148		
R149		
R150		
R151		
R152		
R153		
R154		
R155		
R156		
R157		
R158		
R159		
R160		
R161		
R162		
R163		
R164		
R165		
R166		
R167		
R168		
R169		
R170		
R171		
R172		
R173		
R174		
R175		
R176		
R177		
R178		
R179		
R180		
R181		
R182		
R183		
R184		
R185		
R186		
R187		
R188		
R189		
R190		
R191		
R192		
R193		
R194		
R195		
R196		
R197		
R198		
R199		
R200		

# USA900 Schematic

THIS DOCUMENT CONTAINS PROPRIETARY INFORMATION OF OSC AUDIO PRODUCTS. IT IS THE PROPERTY OF OSC AUDIO PRODUCTS AND IS NOT TO BE DISCLOSED, REPRODUCED OR USED WITHOUT EXPRESS WRITTEN CONSENT FROM OSC AUDIO PRODUCTS

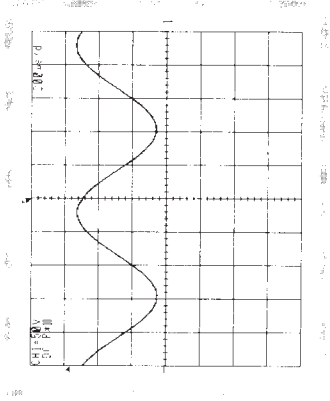

JACK PLANE

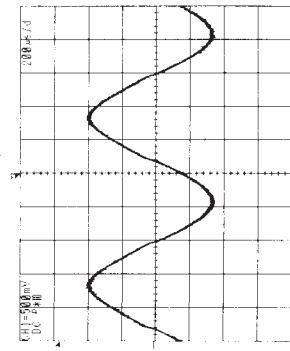
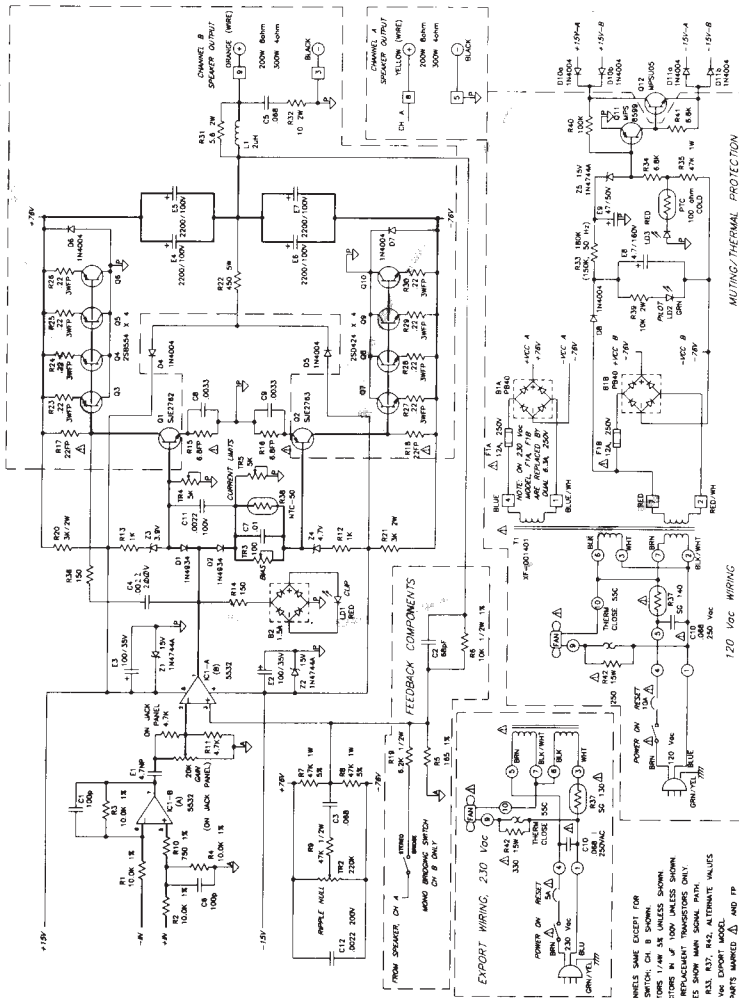
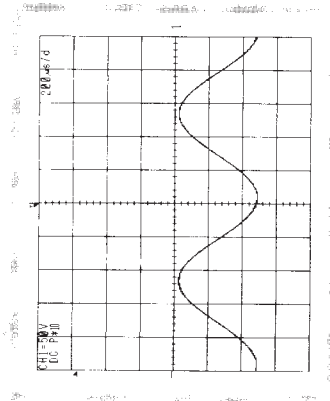
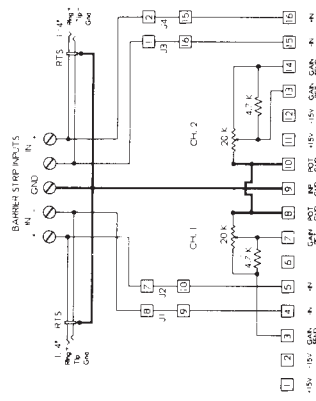

- NOTES**
1. CHANNELS USE CASES FOR BRIDGE SWITCH, CH B SHOWN.
  2. ALL RESISTORS 1/4W 5% UNLESS SHOWN.
  3. ALL CAPACITORS 50V UNLESS SHOWN.
  4. ALL DIMENSIONS IN INCHES UNLESS SHOWN.
  5. HEAVY LINES SHOW MAIN SIGNAL PATH.
  6. F16, F18, R13, R17, R18, ALTERNATE VALUES FOR 330Vdc EXPORT MODEL.
  7. WITH SAME TYPE BULKY JACKS.
  8. ALL RESISTORS MARKED 5% ARE OF FLAMEPROOF CONSTRUCTION AND MINIMUM OF 1/2 WATT.
  9. DIMENSIONS SHOWN IN PARENTHESES ARE MINIMUMS.
  10. ALL DIMENSIONS ARE IN INCHES UNLESS SHOWN.
  11. A AND B PHONES 7.65 OHMS (1.25 ON CHANNEL A).

PART	USED	NOT USED
R2		
R11		
R12		
R13		
R14		
R15		
R16		
R17		
R18		
R19		
R20		
R21		
R22		
R23		
R24		
R25		

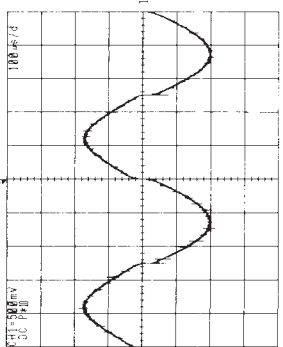
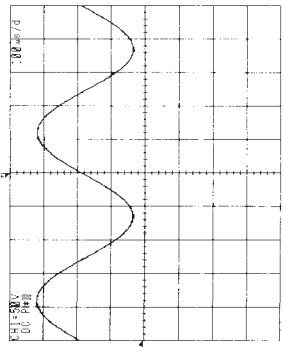
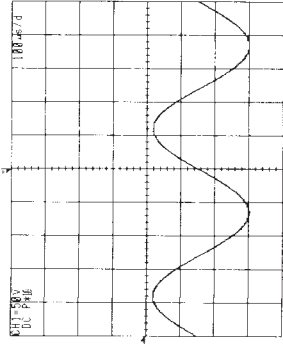

- NOTES:
- BOTH CH. SAME EXCEPT FOR BRIDGING SW (CH 2 SHOWN).
  - ALL RESISTORS 1/4 WATTS 5% UNLESS SHOWN.
  - ALL CAPACITORS IN UF. 100V UNLESS SHOWN.
  - HEAVY LINE SHOWS MAIN SIGNAL PATH.
  - USE OSC REPLACEMENT TRANSISTORS ONLY.
  - FP--FLAME PROOF RESISTORS.
  - Z1--Z6 ZENER DIODES.
  - B1--B3 BRIDGE RECTIFIERS.
  - LD1--LD2 FRONT PANEL LED'S.

